















NEW HOLLAND 1520

				
1	REEL DRIVE	1	80333255	0202332
2	KNIFE DRIVE	1	80337415	1602195
3	REEL VARIATOR	1	80334065	0310109
4	INTERMEDIATE SHAFT - KNIFE	1	80330715	0202275
5	STRAW ELEVATOR DRIVE	1	80230059	0102216
6	GROUND SPEED VARI-DRIVE	1	80364418	0311177
7	BEATER DRIVE	1	80230079	0381384
8	HYDRAULIC PUMP	1	80230043	0401111
9	GROUND SPEED	1	80328424	0330336
10	ECCENTRIC DRIVE	1	80230061	0202268
11	STRAW WALKER	1	80230046	0301183
12	FAN BELT (DEUTZ ENG)	1	80327040	0173231
13	GENERATOR BELT (DEUTZ ENG)	1	80327041	0273217
14	FAN BELT (FORD ENG)	1	80371222	0172225
15	TAILINGS ELEVATOR	1	80230046	0301183
16	UNLOADING SYSTEM	1	80326298	0102129
17	DRUM VARI-DRIVE	1	80230078	0213186
18	FAN VARI-DRIVE	1	80330204	1901133





NEW HOLLAND 1530

				
1	REEL DRIVE	1	80333255	0202332
2	KNIFE DRIVE	1	80337415	1602195
3	REEL VARIATOR DRIVE	1	80334065	0310109
4	INTERMEDIATE KNIFE DRIVE	1	80330715	0202275
5	STRAW ELEVATOR DRIVE	1	80230073	0330293
6	ECCENTRIC DRIVE	1	80230060	0202235
8	AUGER DRIVE	1	80309364	1602150
8	BEATER DRIVE	1	80230080	0381385
9	HYDRAULIC PUMP DRIVE	1	80230043	0401111
11	FAN BELT (DEUTZ ENG)	1	80336386	1573238
12	GENERATOR BELT (DEUTZ ENG)	1	80336426	0373221
12	ALTERNATOR BELT (DEUTZ ENG)	1	80386155	0373225
13	FAN BELT	1	80371222	0172225
14	GRAIN ELEVATOR DRIVE	1	80230062	0302313
14	GRAIN ELEVATOR DRIVE	1	80230059	0102216
15	FAN BELT (PERKINS ENGINE)	1	80353882	0172235
16	TAILINGS ELEVATOR DRIVE	1	80230057	0302179
17	RETURN AUGER DRIVE	1	80230041	2601079
18	UNLOADING SYSTEM	1	80230103	0330188
19	DRUM VARI-DRIVE	1	80230078	0213186
20	FAN VARI-DRIVE	1	80230056	0402155
21	ECCENTRIC AND STRAW WALKER	1	80230108	1601218





NEW HOLLAND 1540 - 1540 AL

				
x	HYDRAULIC PUMP	1	80398748	0324237
x	HYDRAULIC PUMP	1	80350236	0324284
1	REEL DRIVE	1	80333255	0202332
2	KNIFE DRIVE	1	80337415	1602195
3	REEL SPEED VARI-DRIVE	1	80334065	0310109
4	SICKLE KNIFE DRIVE	1	80362500	0301276
5	DRIVE DRUM-VARIATOR	1	80336784	0313181
6	HYDRAULIC PUMP	1	80335258	0401111
7	MAIN SHAFT DRIVE	1	80323646	0325214
8	UNLOADING SYSTEM	1	80333958	0302262
9	DRUM VARI-DRIVE	1	80336784	0313181
9	DRUM VARI-DRIVE	1	80355797	0213186
12	GRAIN ELEVATOR DRIVE	1	80230164	2002190
12	GRAIN ELEVATOR DRIVE	1	80353584	2002283
13	ROTARY SCREEN DRIVE	1	80354338	0300064
14	TAILINGS ELEVATOR	1	80323413	1602150
15	INTERMEDIATE REEL. KNIFE	1	80324391	0303257
16	FAN DRIVE	1	80230059	0102216
17	ECCENTRIC AND STRAW WALKER	1	80333347	0305278
17	ECCENTRIC AND STRAW WALKER	1	80378672	0305315
18	FAN VARI-DRIVE	1	80320935	0309132
19	DEUTZ ENGINE	1	80336386	1573238
19	FORD ENGINE	1	80371222	0172225
19	DEUTZ ENGINE	1	80386155	0373225





NEW HOLLAND 1545

				
1	REEL DRIVE	1	80333255	0202332
2	KNIFE DRIVE	1	80337415	1602195
3	VARIABLE REEL SPEED	1	80334065	0310109
4	INTERMEDIATE SHAFT. KNIFE	1	80643353	0401279
5	STRAW ELEVATOR DRIVE	1	80230073	0330293
6	ECCENTRIC DRIVE	1	80230060	0202235
8	BEATER DRIVE	1	80230080	0381385
9	HYDRAULIC PUMP	1	80230043	0401111
10	UNLOADING SYSTEM	1	80309364	1602150
11	STRAW WALKER	1	80230108	1601218
12	FAN BELT FORD	1	80371222	0172225
13	GRAIN ELEVATOR	1	80230062	0302313
13	GRAIN ELEVATOR DRIVE	1	80230059	0102216
14	TAILINGS ELEVATOR	1	80230057	0302179
15	RETURN AUGER DRIVE	1	80230041	2601079
16	DRUM VARI-DRIVE	1	80230078	0213186
17	FAN VARI-DRIVE	1	80230056	0402155





NEW HOLLAND 1550

				
1	REEL DRIVE	1	80333255	0202332
2	KNIFE DRIVE	1	80337415	1602195
3	REEL VARIATOR	1	80334065	0310109
4	INTERMEDIATE SHAFT. KNIFE	1	80362500	0301276
5	DRUM VARIATOR	1	80336784	0313181
6	HYDRAULIC PUMP	1	80230043	0401111
6	HYDRAULIC PUMP	1	80335258	0401111
7	MAIN SHAFT DRIVE	1	80323646	0325214
8	UNLOADING SYSTEM	1	80333958	0302262
9	DRUM VARI-DRIVE	1	80336784	0313181
9	DRUM VARI-DRIVE	1	80355797	0213186
10	GROUND SPEED	1	80356025	0313271
11	GROUND SPEED VARI-DRIVE	1	80356025	0313271
12	FAN BELT	1	80364033	0172225
13	FAN BELT	1	80230039	0372234
14	GRAIN ELEVATOR	1	80230164	2002190
15	ROYARY SCREEN DRIVE	1	80354338	0300064
16	TAILINGS ELEVATOR	1	80323413	1602150
17	INTERMEDIATE REEL. KNIFE	1	80324391	0303257
18	FAN DRIVE	1	80320059	/
19	ECCENTRIC AND STRAW WALKER	1	80333347	0305278
19	STRAW WALKER	1	80378672	0305315
20	FAN VARI-DRIVE	1	80320935	0309132
21	CENTRIFUGAL SEPARATOR	1	80356913	0302134
21	GRAIN ELEVATOR	1	80353584	2002283





NEW HOLLAND 8030

				
2	FORD ENGINE	1	80443634	0372223
3	HYDRAULIC PUMP	1	80393519	0372257
4	UNLOADING GRAIN TANK	1	80422725	0102137
6	DRUM VARI-DRIVE	1	80336784	0313181
7	FAN VARI-DRIVE	1	80230057	0302179
8	FAN VARI-DRIVE	1	80395955	0302134
9	ECCENTRIC AND STRAW WALKER DRIVE	1	80431784	0301217
13	ELEVATOR DRIVE UNIT	1	80422731	0302248
15	ECCENTRIC DRIVE	1	80387469	0302251
16	STRAW ELEVATOR DRIVE	1	80066232	2602244
17	HEADER DRIVE	1	80330715	0202275

NEW HOLLAND 8040

				
2	ALTERNATOR AND WATER PUMP DRIVE	1	80443636	0373221
2	ALTERNATOR AND WATER PUMP DRIVE	1	80443634	0372223
3	RADIATOR FAN DRIVE	1	80427455	1699317
5	DRUM VARI-DRIVE	1	80336784	0313181
7	UPPER CLEANING FAN DRIVE	1	80230057	0302179
8	LOWER CLEANING FAN DRIVE	1	80395955	0302134
9	STRAW WALKER DRIVE	1	80431784	0301217
10	BEATER DRIVE	1	80422281	0124297
13	GRAIN ELEVATOR BOTTOM AUGER	1	80422731	0302248
15	ECCENTRIC SHAFT DRIVE	1	80387469	0302251
16	STRAW ELEVATOR DRIVE	1	80066232	2602244
17	HEADER DRIVE	1	80330715	0202275
18	ROTARY DUST SCREEN DRIVE	1	80422441	0300206
19	INTERMEDIATE SHAFT DRIVE FOR FAN	1	80427456	0101168
20	HYDRAULIC PUMP DRIVE	1	80393519	0372257
21	GRAIN TANK BOTTOM AUGER	1	80230164	2002190

NEW HOLLAND 8050

				
1	REEL DRIVE	1	80333255	0202332
2	KNIFE DRIVE	1	80337415	1602195
3	REEL SPEED VARI-DRIVE	1	80334065	0310109
5	MAIN SHAFT DRIVE	1	80397298	0325209
5	BEATER DRIVE	1	80451481	0325209
6	DRUM VARI-DRIVE	1	80397297	0324279
7	HYDRAULIC PUMP	1	80230151	1601103
8	INTERMEDIATE SCREEN SHAFT DRIVE	1	80389245	1401145
9	GROUND SPEED DRIVE (STANDARD SPEED)	1	80230076	0112182
9	GROUND SPEED DRIVE (REDUCED SPEED)	1	80420606	0312172
9	GROUND SPEED DRIVE (STANDARD SPEED)	1	80424318	0112182
10	STRAW WALKER DRIVE	1	80605529	0401279
11	INTERMEDIATE GRAIN SHAFT AUGER	1	80410896	0302146
12	STRAW ELEVATOR DRIVE	1	80393326	0323270
13	INTERMEDIATE CUTTER SHAFT DRIVE (8060)	1	80394426	0101298
13	INTERMEDIATE CUTTER SHAFT DRIVE (8050)	1	80643353	0401279
14	GROUND SPEED	1	80230077	0812262
14	SPEED VARI-DRIVE	1	80356024	0812262
15	ALTERNATOR DRIVE (FORD ENGINE 2704 ET)	1	80371222	0172225
15	ALTERNATOR AND WATER PUMP DRIVE (MERCEDES ENGINE)	1	80421173	0372232
15	ONLY 8060 AIFO-FIAT ENGINE	1	80432802	0373225
15	FORD ENGINE	1	81540767	1472227
16	INTERMEDIATE SCREEN SHAFT DRIVE	1	80399058	0372268
17	DUST FILTER	1	80381489	0300212
17	DUST SCREEN DRIVE	1	80457643	0300212
18	GRAIN TAILINGS AUGER (SUPERIOR)	1	80387469	0302251
19	FAN DRIVE	1	80378989	1901133
20	FAN DRIVE	1	80388280	2610138
21	DRUM VARI-DRIVE	1	80336784	0313181
22	BEATER DRIVE 8050 (201 = 4406001 - 4411999)	1	80396750	0402153
22	BEATER DRIVE 8060 (330 = 4313001 - 4321999)	1	80396750	0402153
22	BEATER DRIVE 8050 (30 = 4412001 -)	1	80437033	0402155
22	BEATER DRIVE 8060 (40 = 4322001 -)	1	80437033	0402155
23	INTERMEDIATE BEATER SHAFT DRIVE	1	80395955	0302134

NEW HOLLAND 8055

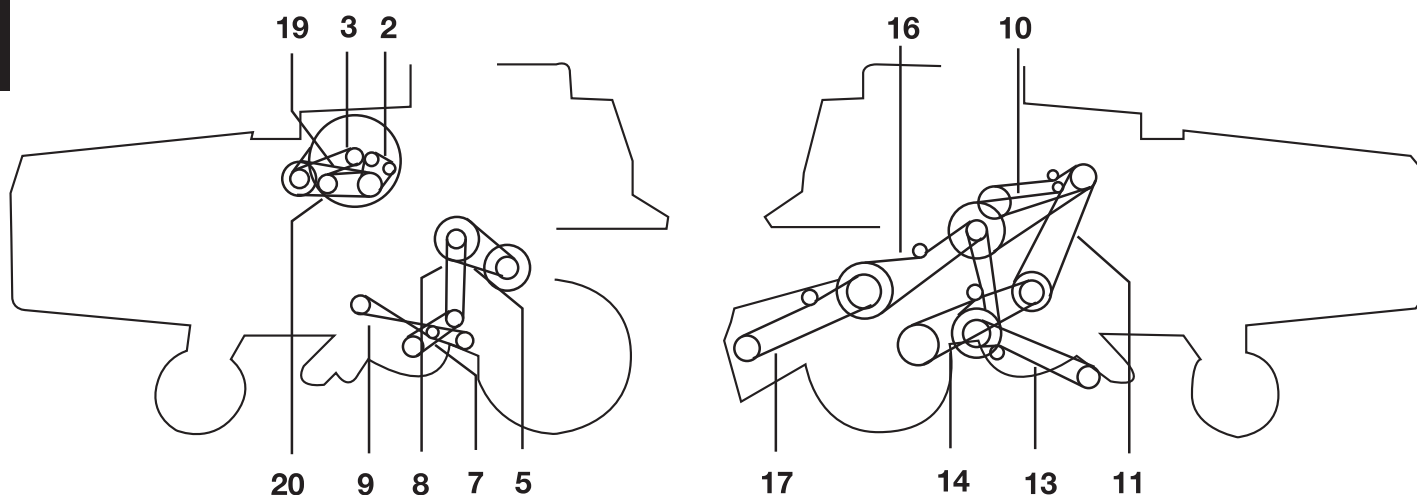

2	ALTERNATOR AND WATER PUMP DRIVE (FORD)	1	80443634	0372223
2	ALTERNATOR AND WATER PUMP DRIVE (MERCEDES)	1	80444045	0372231
3	FAN DRIVE	1	80427455	1699317
5	DRUM VARI-DRIVE	1	80336784	0313181
7	FAN DRIVE	1	80230057	0302179
8	FAN DRIVE	1	80395955	0302134
9	STRAW WALKER DRIVE	1	80431784	0301217
10	BEATER DRIVE	1	80447031	0324299
13	GRAIN ELEVATOR BOTTOM AUGER	1	80422731	0302248
15	ECCENTRIC SHAFT DRIVE	1	80387469	0302251
16	STRAW ELEVATOR DRIVE	1	80066232	2602244
16	STRAW ELEVATOR DRIVE	1	80424563	0327292
17	HEADER DRIVE	1	80394426	0101298
18	ROTARY DUST SCREEN DRIVE	1	80422441	0300206
19	INTERMEDIATE SHAFT (DUST SCREEN DRIVE)	1	80427456	0101168
20	HYDRAULIC PUMP DRIVE	1	80393519	0372257
21	INTERMEDIATE DRIVE SHAFT	1	80447041	0302197

NEW HOLLAND 8060

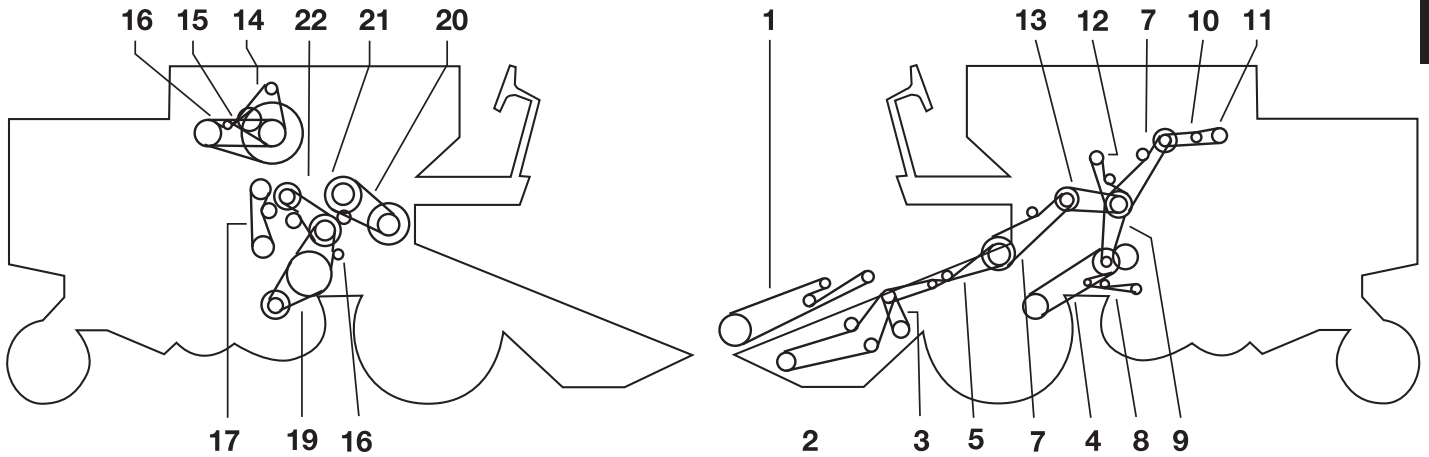

1	REEL DRIVE	1	80333255	0202332
2	KNIFE DRIVE	1	80337415	1602195
3	REEL SPEED VARI-DRIVE	1	80334065	0310109
5	MAIN SHAFT DRIVE	1	80397298	0325209
5	BEATER DRIVE	1	80451481	0325209
6	DRUM VARI-DRIVE	1	80397297	0324279
7	HYDRAULIC PUMP	1	80230151	1601103
8	INTERMEDIATE SCREEN SHAFT DRIVE	1	80389245	1401145
9	GROUND SPEED DRIVE (STANDARD SPEED)	1	80230076	0112182
9	GROUND SPEED DRIVE (REDUCED SPEED)	1	80420606	0312172
9	GROUND SPEED DRIVE (STANDARD SPEED)	1	80424318	0112182
10	STRAW WALKER DRIVE	1	80605529	0401279
11	INTERMEDIATE GRAIN SHAFT AUGER	1	80410896	0302146
12	STRAW ELEVATOR DRIVE	1	80393326	0323270
13	INTERMEDIATE CUTTER SHAFT DRIVE (8060)	1	80394426	0101298
13	INTERMEDIATE CUTTER SHAFT DRIVE (8050)	1	80643353	0401279
14	GROUND SPEED	1	80230077	0812262
14	SPEED VARI-DRIVE	1	80356024	0812262
15	ALTERNATOR DRIVE (FORD ENGINE 2704 ET)	1	80371222	0172225
15	ALTERNATOR AND WATER PUMP DRIVE (MERCEDES ENGINE)	1	80421173	0372232
15	ONLY 8060 AIFO-FIAT ENGINE	1	80432802	0373225
15	FORD ENGINE	1	81540767	1472227
16	INTERMEDIATE SCREEN SHAFT DRIVE	1	80399058	0372268
17	DUST FILTER	1	80381489	0300212
17	DUST SCREEN DRIVE	1	80457643	0300212
18	GRAIN TAILINGS AUGER (SUPERIOR)	1	80387469	0302251
19	FAN DRIVE	1	80378989	1901133
20	FAN DRIVE	1	80388280	2610138
21	DRUM VARI-DRIVE	1	80336784	0313181
22	BEATER DRIVE 8050 (201 = 4406001 - 4411999)	1	80396750	0402153
22	BEATER DRIVE 8060 (330 = 4313001 - 4321999)	1	80396750	0402153
22	BEATER DRIVE 8050 (30 = 4412001 -)	1	80437033	0402155
22	BEATER DRIVE 8060 (40 = 4322001 -)	1	80437033	0402155
23	INTERMEDIATE BEATER SHAFT DRIVE	1	80395955	0302134

NEW HOLLAND 8070

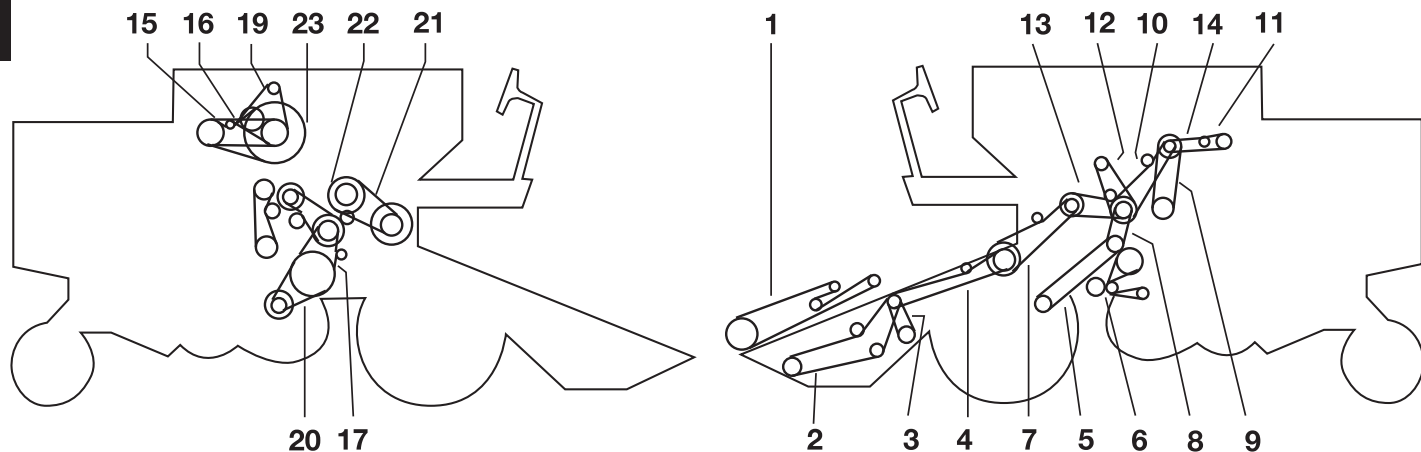



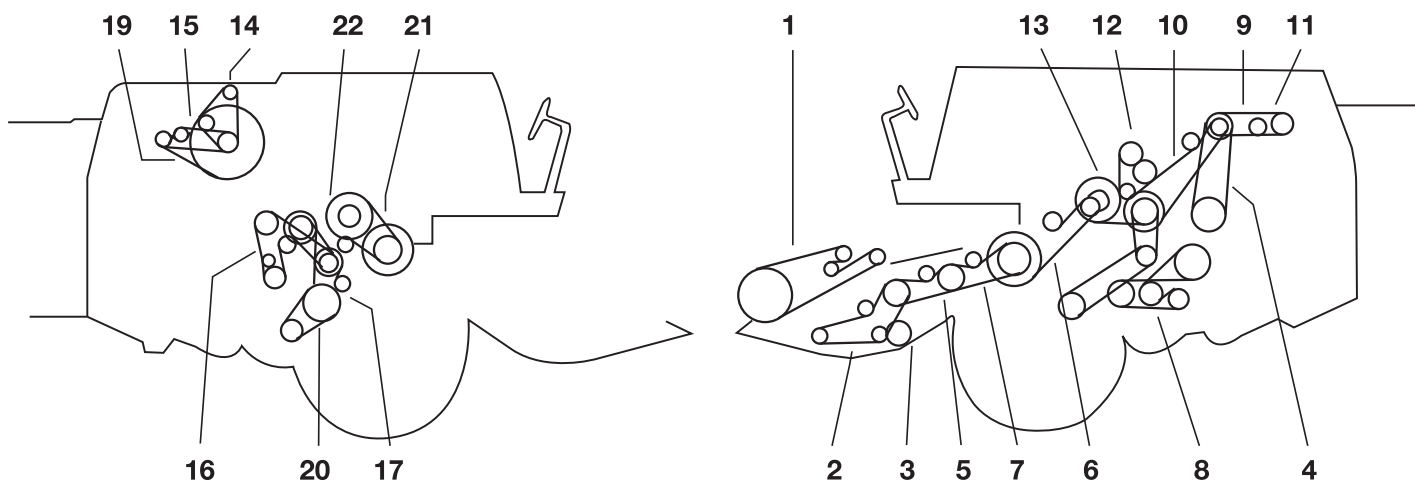

1	REEL DRIVE	1	80333255	0202332
2	KNIFE DRIVE	1	80337415	1602195
3	REEL SPEED VARI-DRIVE	1	80334065	0310109
4	HEADER DRIVE	1	80394426	0101298
5	GROUND SPEED VARI-DRIVE	1	80356025	0313271
6	GROUND SPEED - LOW - PULLEY 350 MM	1	80417643	0213186
6	GROUND SPEED - NORMAL - PULLEY 404 MM	1	80321559	1413193
7	STRAW ELEVATOR DRIVE	1	80393326	0323270
8	STRAW WALKER DRIVE	1	80605529	0401279
9	HYDROSTATIC DRIVE	1	80411543	0325248
10	DRUM VARIATOR	1	80391650	0325282
11	INTERMEDIATE DRIVE SHAFT	1	80389245	1401145
12	INTERMEDIATE SHAFT (GRAIN AUGER)	1	80410896	0302146
13	RETHRESHER DRIVE	1	80387454	0325209
13	RETHRESHER DRIVE	1	80451481	0325209
14	HYDRAULIC PUMP DRIVE	1	80230151	1601103
15	FAN DRIVE	1	80384397	0372272
16	DUST SCREEN DRIVE	1	80381489	0300212
17	FAN DRIVE	1	80378989	1901133
18	TAILINGS ELEVATOR DRIVE	1	80387469	0302251
19	ALTERNATOR DRIVE (MERCEDES OM 352A)	1	80421173	0372232
19	ALTERNATOR DRIVE (FORD 2704 ET)	1	80371222	0172225
20	FAN VARI-DRIVE	1	80388280	2610138
21	DRUM VARI-DRIVE	1	80387460	0315188
22	COUNTERSHAFT DRIVE	1	80396750	0402153
22	COUNTERSHAFT DRIVE	1	80437033	0402155
23	VARIATOR DRIVE	1	80395955	0302134

NEW HOLLAND 8080







1	REEL DRIVE	1	80333255	0202332
2	KNIFE DRIVE	1	80337415	1602195
3	REEL SPEED VARI-DRIVE	1	80334065	0310109
4	HYDROSTATIC DRIVE	1	80411543	0325248
5	HEADER DRIVE	1	80387931	0301147
6	STRAW ELEVATOR DRIVE	1	80393326	0323270
7	HEADER DRIVE	1	80391143	0301217
8	STRAW WALKER DRIVE	1	80605529	0401279
9	HYDRAULIC PUMP DRIVE	1	80230151	1601103
10	DRUM VARIATOR	1	80391650	0325282
11	INTERMEDIATE DRIVE SHAFT	1	80389245	1401145
12	INTERMEDIATE SHAFT (GRAIN AUGER)	1	80410896	0302146
13	RETHRESHER DRIVE	1	80387454	0325209
13	RETHRESHER DRIVE	1	80451481	0325209
14	ALTERNATOR DRIVE (MERCEDES OM 401)	1	80393519	0372257
14	ALTERNATOR DRIVE (MERCEDES OM 421)	1	80432642	0372258
15	FAN DRIVE (MERCEDES OM 401)	1	80384397	0372272
16	DUST SCREEN DRIVE	1	80381489	0300212
17	FAN DRIVE	1	80378989	1901133
18	TAILINGS ELEVATOR DRIVE	1	80387469	0302251
20	FAN VARI-DRIVE	1	80388280	2610138
21	DRUM VARI-DRIVE	1	80387460	0315188
22	COUNTERSHAFT DRIVE	1	80396750	0402153
22	COUNTERSHAFT DRIVE	1	80437033	0402155
23	VARIATOR DRIVE	1	80395955	0302134

NEW HOLLAND 9630 - 9640 - 9645





				
1	MAIN DRIVE	1	84017742	0357271
2	DRIVE	1	84026761	0300223
3	FAN	1	84012975	0372307
4	ALTERNATOR	1	84022807	0372275
5	COMPRESSOR	1	89835815	0372242
5	COMPRESSOR	1	80747177	0272247

NEW HOLLAND CS 520 - CS 540 - CS 640 - CS 660

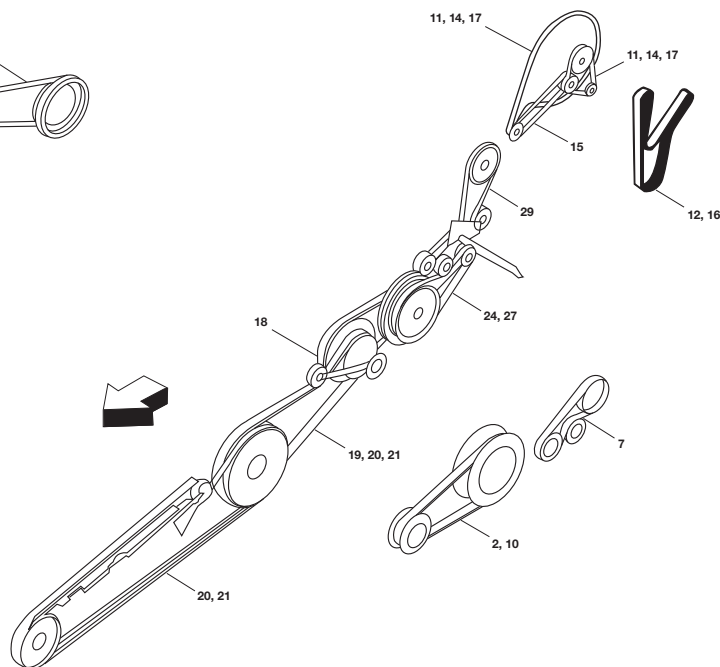
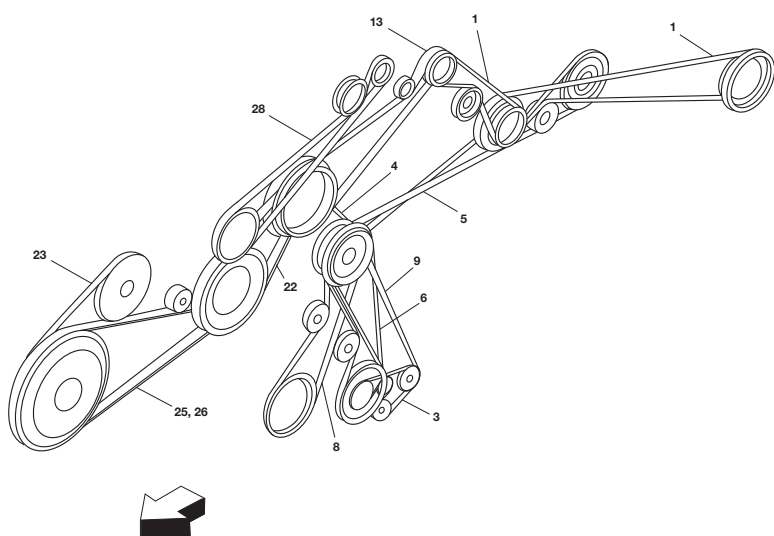
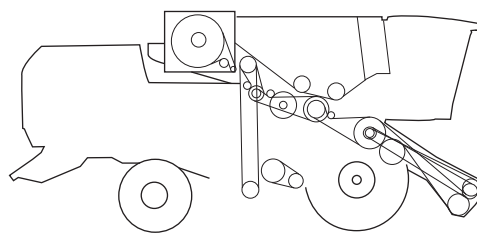
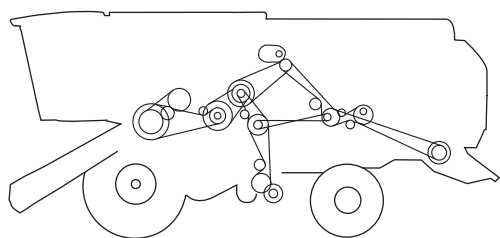
				
1	ALTERNATOR, WATERPUMP, COMPRESSOR	1	84817638	0385359
2	MAIN TRANSMISSION	1	84993120	0325376
3	CHAFF SPREADER (FOR CS520 & CS540 ONLY)	1	84790355	0304255
3	CHAFF SPREADER (FOR CS640 & CS660 ONLY)	1	84790356	0104278
4	CHAFF SPREADER	1	84790244	1201153
5	CHOPPER DRIVE	1	84076421	0323453
6	CHOPPER DRIVE	1	84075955	1623354
7	GRASS SEED EQUIPMENT	1	84452153	1510140
8	GRASS SEED EQUIPMENT	1	84452112	0301131
9	GRAIN ELEVATOR BOTTOM DRIVE	1	80422731	0302248
10	FAN VARI-DRIVE	1	84073979	1510174
11	SHAKER SHOE DRIVE	1	84015531	0102176
12	STRAW WALKER DRIVE	1	84073276	1401231
13	DRUM DRIVE	1	84072772	1825189
13	DRUM DRIVE (LOW DRUM SPEED)	1	84072815	1225216
14	ROTARY SEPERATOR DRIVE AND SHAFT	1	84073933	2602145
15	DRUM VARIATOR	1	84035748	0353283
16	STRAW ELEVATOR DRIVE 2HB (NOT FOR CS520)	1	84981586	0323507
16	STRAW ELEVATOR DRIVE 3HB	1	84982278	0323430
16	STRAW ELEVATOR DRIVE 2HB (FOR CS520 ONLY)	1	84991234	0324509
17	HEADER DRIVE ENGAGING IDLER (2HB ONLY)	1	84446792	1623311
17	HEADER DRIVE ENGAGING IDLER (3HB ONLY/NOT CS520)	1	89817374	1524314
18	BLOW-OFF SYSTEM, AIR COMPRESSOR	1	84061465	1472251
19	DRIVE, ROTARY SCREEN AND FAN	1	84061465	1472251
19	DRIVE, ROTARY SCREEN AND FAN	1	84989965	1400235
19	DRIVE, ROTARY SCREEN AND FAN	1	89501182	0372245
20	HYDROSTATIC PUMP DRIVE (NOT FOR CS660)	1	84607712	0324261
20	HYDROSTATIC PUMP DRIVE (FOR CS660 ONLY)	1	84607713	0324271
21	HYDRAULIC PUMP DRIVE	1	80427456	0101168
22	UNLOADING AUGER	1	84991836	0502215





NEW HOLLAND CX 840



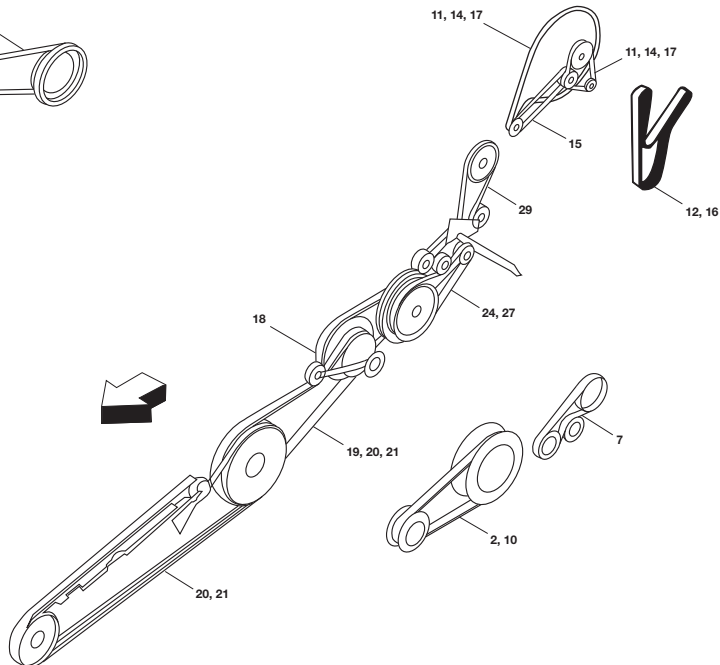
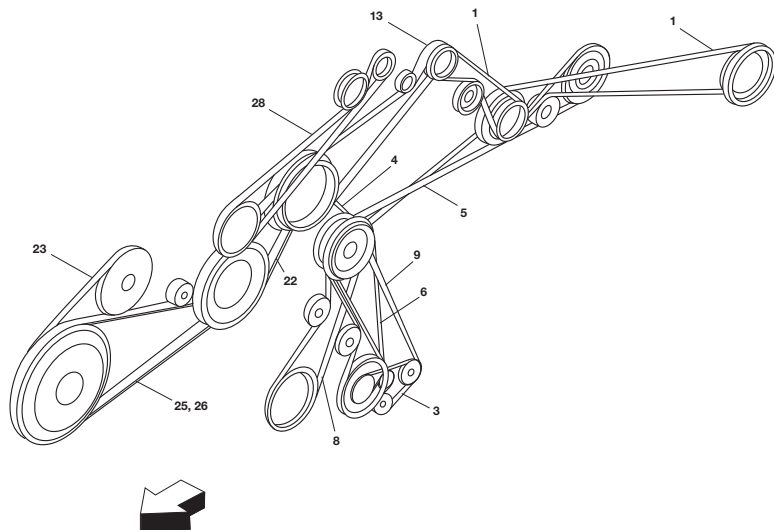
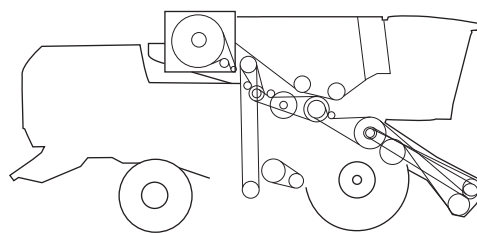
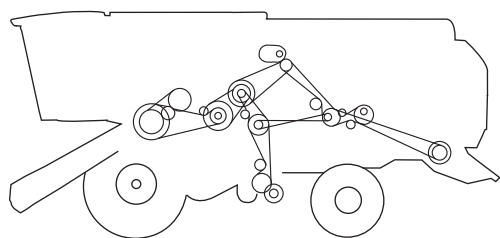



				
1	CHOPPER DRIVE	1	84075345	1423286
1	CHOPPER DRIVE	1	84075635	0223404
2	GRASS SEED EQUIPMENT - ACCESSORIES FOR SELF LEVELLING ONLY	1	84023277	0303117
2	GRASS SEED EQUIPMENT - ACCESSORIES FOR FIXED SHOE ONLY	1	84023278	0360230
3	SHAKER SHOE DRIVE - SELF-LEVELLING	2	84056913	1201153
4	INTERMEDIATE SHAFT FOR CLEANING DRIVE	1	84057392	0223201
5	STRAW WALKER DRIVE	1	84057482	0301339
6	SHAKER SHOE AND TAILINGS ELEVATOR DRIVE, SELF LEVELLING	1	84057874	0302251
7	TAILINGS ELEVATORS, BOTTOM AUGER AND (RH)DRIVE	2	84058339	0101087
8	SHAKER SHOE DRIVE, FIXED SHOE	1	84432785	0202235
9	TAILINGS ELEVATOR DRIVE, FIXED SHOE	1	84435035	1123301
10	FAN VARI-DRIVE FOR FIXED SHOE ONLY	1	919739	0303147
10	FAN VARI-DRIVE FOR SELF LEVELLING ONLY	1	9502654	0303144
11	ROTARY SCREEN AND FAN	1	84057085	0100272
12	DRIVE : ALTERNATOR, WATERPUMP AND AIR COMPRESSOR	1	84057710	0385354
13	MAIN DRIVE	1	84057914	1425268
14	DRIVE, ROTARY SCREEN AND FAN	1	84061465	1472251
15	BLOW-OFF SYSTEM, AIR COMPRESSOR	1	84061465	1472251
16	ALTERNATOR, WATERPUMP AND AIR COMPRESSOR HIGH FAN SPEED ONLY	1	86013886	/
17	ROTARY SCREEN AND FAN	2	87337385	0122155
17	ROTARY SCREEN AND FAN	2	9835816	0172253
18	HEADER	1	84061279	0724325
19	DRIVE STRAW ELEVATOR	1	84334995	0325607
20	STRAW ELEVATOR DRIVE	1	84434260	1423476
21	STRAW ELEVATOR DRIVE	1	84434295	1123301
22	DRUM VARIATOR	1	84035748	0353283
23	BEATER, DRIVE	1	84045256	1902204
24	ROTARY SEPARATOR DRIVE AND SHAFT	1	84057393	0223204
25	DRUM-DRIVE WITH REDUCTOR	1	84061615	1824328
26	DRUM DRIVE WITHOUT REDUCTOR	1	84061615	1824328
27	ROTARY SEPARATOR DRIVE AND SHAFT	1	84457079	0223204
28	UNLOADING AUGER	1	84061293	0323284
29	GRAIN ELEVATOR , DRIVE	1	84073457	0301147

NEW HOLLAND CX 860 - CX 880







				
1	CHOPPER DRIVE	1	84075345	1423286
1	CHOPPER DRIVE	1	84075635	0223404
2	GRASS SEED EQUIPMENT - ACCESSORIES FOR SELF LEVELLING ONLY	1	84023277	0303117
2	GRASS SEED EQUIPMENT - ACCESSORIES FOR FIXED SHOE ONLY	1	84023278	0360230
3	SHAKER SHOE DRIVE - SELF-LEVELLING	2	84056913	1201153
4	INTERMEDIATE SHAFT FOR CLEANING DRIVE	1	84057392	0223201
5	STRAW WALKER DRIVE	1	84057482	0301339
6	SHAKER SHOE AND TAILINGS ELEVATOR DRIVE, SELF LEVELLING	1	84057874	0302251
7	TAILINGS ELEVATORS, BOTTOM AUGER AND (RH)DRIVE	2	84058339	0101087
8	SHAKER SHOE DRIVE, FIXED SHOE	1	84432785	0202235
9	TAILINGS ELEVATOR DRIVE, FIXED SHOE	1	84435035	1123301
10	FAN VARI-DRIVE FOR FIXED SHOE ONLY	1	919739	0303147
10	FAN VARI-DRIVE FOR SELF LEVELLING ONLY	1	9502654	0303144
11	ROTARY SCREEN AND FAN	1	84057085	0100272
12	DRIVE : ALTERNATOR, WATERPUMP AND AIR COMPRESSOR	1	84057710	0385354
13	MAIN DRIVE	1	84057914	1425268
14	DRIVE, ROTARY SCREEN AND FAN	1	84061465	1472251
15	BLOW-OFF SYSTEM, AIR COMPRESSOR	1	84061465	1472251
16	ALTERNATOR, WATERPUMP AND AIR COMPRESSOR HIGH FAN SPEED ONLY	1	86013886	/
18	HEADER	1	84061279	0724325
19	DRIVE STRAW ELEVATOR	1	84334995	0325607
20	STRAW ELEVATOR DRIVE	1	84434260	1423476
21	STRAW ELEVATOR DRIVE	1	84434295	1123301
22	DRUM VARIATOR	1	84035748	0353283
23	BEATER, DRIVE	1	84045256	1902204
24	ROTARY SEPARATOR DRIVE AND SHAFT	1	84057393	0223204
25	DRUM-DRIVE WITH REDUCTOR	1	84061615	1824328
26	DRUM DRIVE WITHOUT REDUCTOR	1	84061615	1824328
27	ROTARY SEPARATOR DRIVE AND SHAFT	1	84457079	0223204
28	UNLOADING AUGER	1	84061293	0323284
29	GRAIN ELEVATOR , DRIVE	1	84073457	0301147





NEW HOLLAND FX 300 - FX 375 - FX 450

				
1	MAIN DRIVE	1	84017742	0357271
2	DRIVE	1	84026761	0300223
3	FAN	1	84012975	0372307
4	ALTERNATOR	1	84022807	0372275
5	COMPRESSOR	1	89835815	0372242
5	COMPRESSOR	1	80747177	0272247





NEW HOLLAND M 80

				
1	HYDRAULIC PUMP	1	80230043	0401111
2	TAILINGS ELEVATOR	1	80230046	0301183
3	DISCHARGE AUGER	1	80230048	0101222
4	REEL INTERMEDIATE DRIVE	1	80230051	0302098
5	STRAW ELEVATOR DRIVE	1	80230059	0102216
6	REEL DRIVE	1	80230060	0202235
7	STICKLE KNIFE DRIVE	1	80230060	0202235
8	GRAIN TANK DRIVE	1	80230061	0202268
9	STRAW BEATER	1	80230267	1402547
10	GROUND SPEED	1	80230074	0330331
11	FAN DRIVE	1	80230074	0330331
12	GROUND SPEED VARIATOR	1	80230075	1511156
13	BEATER DRIVE	1	80230079	0381384
14	FORD ENGINE	1	80230037	0172219
14	DEUTZ ENGINE	1	80230127	0372232
14	FORD ENGINE	1	80230131	0172221
15	DEUTZ ENGINE	1	80230038	0172219
16	GRAIN TANK AUGER	1	80230042	1401081
17	FAN	1	80230044	2101138
18	ELEVATOR	1	80230046	0301183
19	UNLOADING SYSTEM	1	80230053	0302124
20	CYLINDER	1	80230078	0213186





NEW HOLLAND M 89

				
1	HYDRAULIC PUMP	1	80230043	0401111
2	REEL INTERMEDIATE UPPER	1	80230051	0302098
3	STRAW ELEVATOR DRIVE	1	80230059	0102216
4	REEL DRIVE	1	80230060	0202235
5	STICKLE KNIFE DRIVE	1	80230060	0202235
6	GRAIN TANK DRIVE	1	80230061	0202268
7	FAN DRIVE	1	80230074	0330331
8	GROUND SPEED	1	80230075	1511156
9	BEATER DRIVE	1	80230079	0381384
10	TAILINGS ELEVATOR	1	80230046	0301183
11	GENERATOR DRIVE	1	80230038	0172219
12	GRAIN TANK AUGER	1	80230042	1401081
13	FAN DRIVE	1	80230044	2101138
14	ELEVATOR DRIVE UNIT	1	80230046	0301183
15	UNLOADING SYSTEM	1	80230053	0302124
16	CYLINDER	1	80230078	0213186
17	FAN BELT	1	80230127	0372232
17	FAN BELT	1	80230131	0172221





NEW HOLLAND M 103

				
1	THRESHING DRUM DRIVE	1	80230078	0213186
3	BEATER DRIVE	1	80230080	0381385
4	STRAW WALKER DRIVE	1	80230064	0202361
5	TAILINGS ELEVATOR	1	80230054	0402131
6	STRAW ELEVATOR	1	80230073	0330293
7	STICKLE KNIFE DRIVE	1	80230074	0330331
8	REEL INTERMEDIATE SHAFT. LOWER	1	80230057	0302179
9	REEL INTERMEDIATE SHAFT. UPPER	1	80230052	1902102
10	REEL DRIVE	1	80230060	0202235
11	HYDRAULIC PUMP DRIVE	1	80230043	0401111
12	ENGINE FAN DRIVE - PERKINS	1	80230051	0302098
12	ENGINE FAN DRIVE - FORD	1	80230037	0172219
12	ENGINE COOLING BLOWER DRIVE - DEUTZ	1	80230127	0372232
13	GENERATOR DRIVE - DEUTZ	1	80230038	0172219
14	TAILINGS ELEVATOR RETURN	1	80230042	1401081
15	STRAW SPREADER DRIVE	1	80230049	1201291
15	STRAW SPREADER DRIVE / TYPE 9501 M	1	80230050	1401306
16	STRAW PRESS DRIVE	1	80230069	1602631
16	STRAW PRESS DRIVE	1	80230070	0102663
16	STRAW PRESS DRIVE	1	80230071	0302803
17	DISCHARGE AUGER	1	80230053	0302124
18	POWER STEERING	1	80230151	1601103
18	POWER STEERING	1	80230043	0401111
19	STRAW CHOPPER DRIVE	1	80230068	1402587
20	CHOFF BLOWER DRIVE	1	80230066	0102489
21	MAIZE THRESHING DRUM DRIVE	1	80230056	0402155
22	MAIZE REEL DRIVE	1	80230065	0302428
23	MAIZE REEL DRIVE	1	80230063	1902351
24	CHOFF BLOWER DRIVE	1	80230048	0101222
24	CHOFF BLOWER DRIVE	1	80230154	0101245
25	GRAIN TANK AUGER DRIVE	1	80230041	2601079
26	GRAIN TANK AUGER DRIVE	1	80230045	0123190
27	DIVIDING ROLLER	1	80230062	0302313
28	FAN WHEEL DRIVE	1	80230040	0301375

NEW HOLLAND M 122





				
1	HYDRAULIC PUMP	1	80230043	0401111
2	TAILINGS ELEVATOR	1	80230046	0301183
3	STRAW ELEVATOR DRIVE	1	80230059	0102216
4	GRAIN TANK DRIVE	1	80230061	0202268
5	REEL DRIVE	1	80230061	0202268
6	BEATER DRIVE	1	80230079	0381384
7	REEL SPEED DRIVE	1	80230101	0110126
8	SICKLE KNIFE DRIVE	1	80309087	0330351
9	TRACTION DRIVE	1	80326954	0311169
10	TRACTION DRIVE	1	80328424	0330336
11	ELEVATOR DRIVE UNIT	1	80230046	0301183
12	CYLINDER	1	80230078	0213186
13	UNLOADING SYSTEM	1	80326298	0102129
14	FAN DRIVE	1	80330204	1901133
15	DEUTZ ENGINE	1	80327040	0173231
16	DEUTZ ENGINE	1	80327041	0273217
17	FORD ENGINE	1	80327062	0172225

NEW HOLLAND M 133 - M 135 - M 140

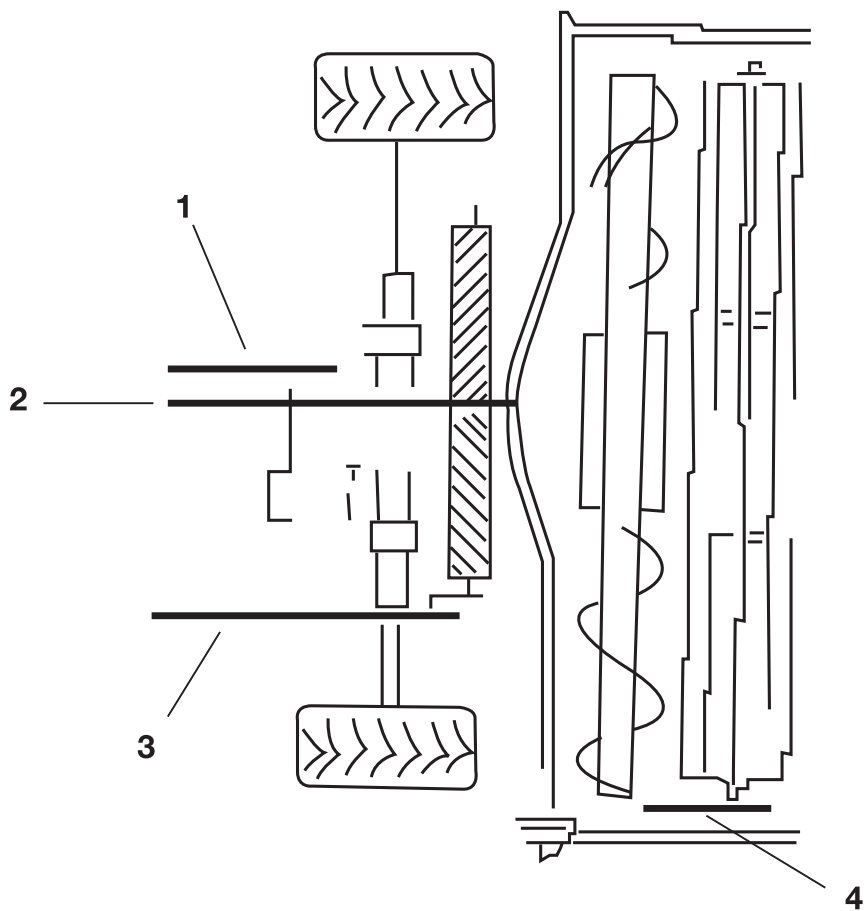
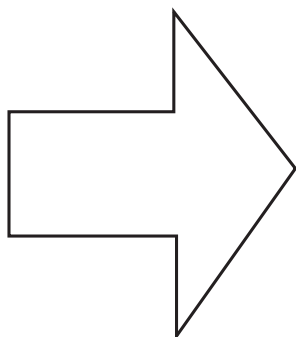



				
1	HYDRAULIC PUMP	1	80230043	0401111
2	REEL ECCENTRIC DRIVE	1	80230060	0202235
3	REEL DRIVE	1	80230061	0202268
4	STRAW ELEVATOR DRIVE	1	80230073	0330293
6	BEATER DRIVE	1	80230080	0381385
7	SICKLE KNIFE DRIVE	1	80309087	0330351
7	CUTTING TABLE	1	80230074	0330331
8	REEL SPEED VARI-DRIVE	1	80230101	0110126
9	STRAW FUNNEL	1	80309364	1602150
10	ROTARY SCREEN	1	80230041	2601079
11	FAN VARI-DRIVE	1	80230056	0402155
12	TAILINGS ELEVATOR DRIVE	1	80230057	0302179
12	GRAIN ELEVATOR	1	80230059	0102216
13	ELEVATOR DRIVE UNIT	1	80230059	0102216
14	CYLINDER	1	80230078	0213186
15	ELEVATOR DRIVE M135	1	80230062	0302313
16	DISCHARGE AUGER	1	80230103	0330188
17	STRAW WALKER DRIVE	1	80230108	1601218
18	FAN BELT	1	80327024	0173234
18	FAN BELT	1	80336386	1573238
19	GENERATOR DRIVE	1	80327041	0273217
19	GENERATOR DRIVE	1	80336426	0373221

NEW HOLLAND SWATHER 1112 - 1114







					
1	JACKSHAFT 3 BAND	1	189130	0324184	
2	HEADER DRIVE	1	182381	1601185	
3	CONDITIONING DRIVE 4 BAND	1	186623	/	
4	REEL	1	137695	/	
1	HEADER CLUTCH 3 GROOVE	1	189131	0324211	
2	HEADER 2 GROOVE	1	643307	0323225	
3	CONDITIONER	1	625241	0325301	
4	REEL	1	189130	0324184	

NEW HOLLAND SWATHER 2450 - 2550

				
1	SICKLE DRIVE AND AUGER	1	703747	2002190
2	CONDITIONER	1	131725	0302197

NEW HOLLAND T 75 - TR 85



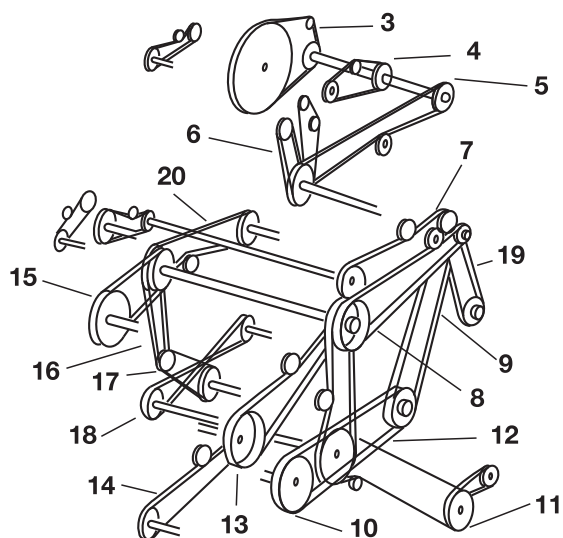

				
1	CLEANING FAN VARI-DRIVE	1	80284521	/
2	SHAKER SHOE DRIVE	1	80717699	0323281
3	STRAW CHOPPER. FRONT	1	80619748	0302224
4	STRAW CHOPPER. REAR	1	80614040	0202305
5	ROTARY SCREEN. LOWER	1	80612305	1472264
6	HYDRAULIC PUMP. TR 85	1	80248332	2001129
6	HYDRAULIC PUMP. TR 75	1	80576772	1901133
7	WATER PUMP AND ALTERNATOR. TR 85	1	80716253	/
8	WATER PUMP ALTERNATOR. TR 75	1	80500594	/
9	ENGINE FAN. TR 85	1	80719213	/
9	ENGINE FAN. TR 75	1	80719214	/
10	ROTARY SCREEN. UPPER	1	80716254	0304325
11	ROTOR VARI-DRIVE	1	80717700	1413195
12	DISCHARGE BEATER	1	80621104	0102148
13	CLEAN GRAIN ELEVATOR DRIVE	1	80703747	2002190
14	HEADER DRIVE	1	80246980	0303317
15	STRAW SPREADER DRIVE	1	80230143	0301375
16	STRAW CHOPPER BEATER DRIVE	1	80246727	0301360
17	STANDARD TRACTION VARI-DRIVE. UPPER	1	80261000	1413195
18	HYDROSTATIC DRIVE. UPPER	1	80716416	0202182
19	STANDARD TRACTION VARI-DRIVE. LOWER	1	80261001	0313269
20	HYDROSTATIC DRIVE. LOWER	1	80716414	0102231
21	UNLOADING AUGER DRIVE	1	80247782	0102216
22	MAIN SHAFT DRIVE. TR 85	1	80246978	0325290
22	MAIN SHAFT DRIVE. TR 75	1	80576771	0325294
23	AIR CONDITIONING COMPRESSOR. TR 85	1	80264557	0172235
23	AIR CONDITIONING COMPRESSOR. TR 75	1	80576776	/
24	HYDROSTATIC CHANGE PUMP	1	80259477	1401129

NEW HOLLAND TC 52 - TC 54 - TC 56







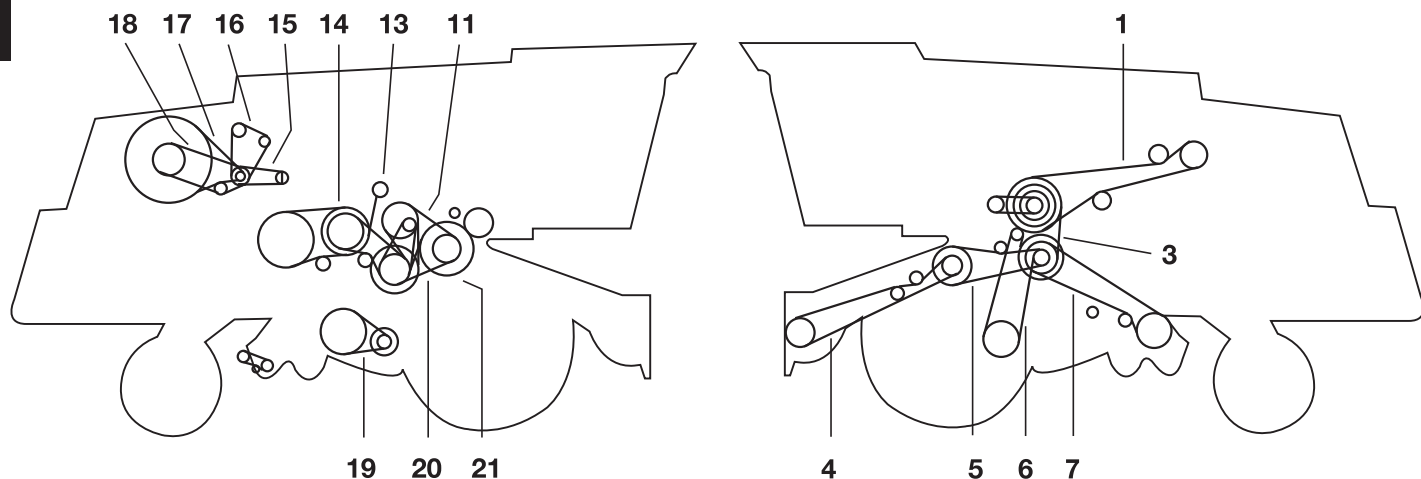

3	ROTARY DUST SCREEN	1	89514310	0300202
4	RADIATOR FAN (FOR TC52 ONLY)	1	89831515	0172253
4	RADIATOR FAN (FOR TC54-56 ONLY)	1	89818704	0372255
5	ENGINE	1	89818705	0372271
x	WATER PUMP - ALTERNATPR - ENG. (WO AIR CO)	1	84005860	0384324
7	INTERMEDIATE SHAFT - ENGINE	1	89838606	0102216
8	BEATERSHAFT - MAIN DRIVE	1	89817374	1524314
11	GRAIN AUGER	1	80422731	0302248
12	BEATER SHAFT - ECCENTRIC SHAFT	1	80387469	0302251
13	STRAW ELEVATOR - BEATER SHAFT	1	80066232	2602244
13	STRAW ELEVATOR - BEATER SHAFT	1	80424563	0327292
14	HEADER DRIVER (CODE 0209) TC56	1	89817487	2002323
14	HEADER DRIVER (CODE 0212) TC52-54	1	89817487	2002323
14	HEADER DRIVER (CODE 0212) TC 52-54	1	89817488	0327376
14	HEADER DRIVER (CODE 0209) TC56	1	89817488	0327376
14	HEADER DRIVER (CODE 1000) F.L. CONV. TC56	1	89835120	0327381
14	HEADER DRIVER (CODE 1300) F.L. CONV. TC52-54	1	89835120	0327381
14	HEADER DRIVER (CODE 1000) F.L. CONV. TC56	1	89839375	0202332
14	HEADER DRIVER (CODE 1300) F.L. CONV. TC52-54	1	89839375	0202332
15	DRUM - BEATER SHAFT	1	80336784	0313181
16	BEATER SHAFT	1	89515075	0310193
17	FAN	1	89515076	0310157
18	STRAW WALKERS - ECCENTRIC SHAFT	1	80431784	0301217
19	HYDROSTATIC PUMP (CODE 0800)	1	89818873	0325248
20	ROTARY SEPARATOR (CODE 2300)	1	89837412	1602150

NEW HOLLAND TC 57

				
1		1	89838606	0102216
2		1	80824182	1472264
3		1	80825117	1225316
4	STRAW ELEVATOR - BEATER SHAFT	1	80424563	0327292
5		1	80825013	0323183
7		1	80330715	0202275
8		1	89575153	0202300
9		1	80755808	2612258
10		1	80753053	0102257
11		1	80824176	0200204
12		1	80724518	/
13		1	80824175	0372271
14		1	89575059	0372242
15	BEATER SHAFT	1	89515075	0310193
16	FAN	1	89515076	0310157
17		1	80387460	0315188
18	STRAW WALKERS - ECCENTRIC SHAFT	1	80431784	0301217





NEW HOLLAND TF 42 - TF 44

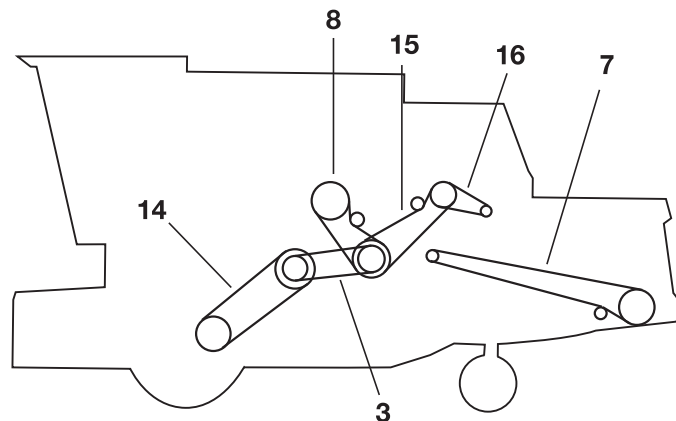
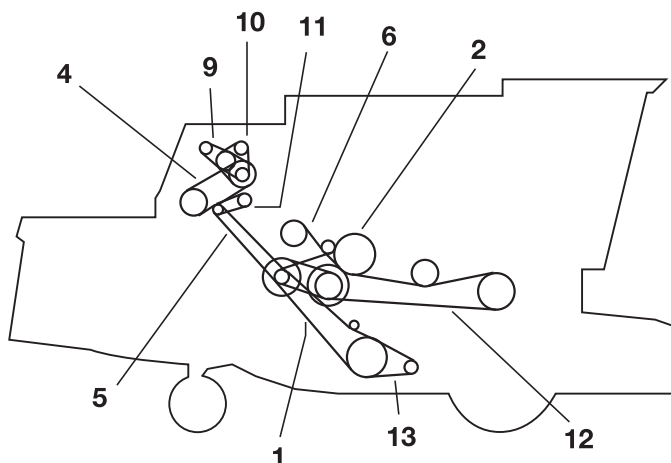

				
1	ENGINE TO BEATER SHAFT	1	80434044	0325367
2	BEATER TO GRAIN TANK INTERMEDIATE SHAFT	1	80445640	0302134
3	BEATER TO INTERMEDIATE SHAFT (FIAT ENGINE)	1	80434045	1425218
3	BEATER TO INTERMEDIATE SHAFT (MERCEDES ENGINE)	1	80455865	1425218
4	STRAW ELEVATOR DRIVE	1	80433746	0301351
5	BEATER TO STRAW ELEVATOR	1	80434222	0323284
5	BEATER TO STRAW ELEVATOR	1	80350236	0324284
5	BEATER TO STRAW ELEVATOR	1	80743877	0225286
6	GROUND SPEED VARIATOR	1	80440780	0313321
7	SHAKER SHOE DRIVE	1	80448794	1402307
11	REAR BEATER TO DRUM SHAFT	1	80186347	0302197
13	INTERMEDIATE SHAFT TO ROTARY SEPARATOR	1	80434047	0323229
14	ROTARY SEPARATOR TO ROTOR	1	80434046	1402217
15	AIR CONDITIONING	1	80381237	0372240
16	AIFO ENGINE	1	80449380	0373262
16	MERCEDES ENGINE	1	80432642	0372258
17	DUST CAP	1	80439495	1400264
18	FAN DRIVE	1	80439496	0372325
19	FAN DRIVE	1	80439832	0310153
20	DRUM SHAFT TO INTERMEDIATE SHAFT	1	80434160	0315204
21	INTERMEDIATE SHAFT TO GRAIN ELEVATOR	1	80433639	1601120

NEW HOLLAND TR 70



				
1	BEATER DRIVE	1	621104	0102148
2	GRAIN ELEVATOR DRIVE	1	703747	2002190
3	GROUND SPEED VARI-DRIVE	1	261000	1413195
4	HYDRAULIC PUMP DRIVE (GAS AND CAT DIESEL)	1	248332	2001129
4	HYDRAULIC PUMP DRIVE (FORD DIESEL ENGINE)	1	576772	1901133
5	ROTARY SCREEN. JACKSHAFT DRIVE	1	246771	1900132
6	ROTOR DRIVE	1	254093	1913200
6	ROTOR DRIVE (OPT FOR HIGH SPEED)	1	715785	1413193
7	STRAW CHOPPER DRIVE	1	578206	0101321
7	STRAW SPREADER	1	246727	0301360
7	STRAW SPREADER	1	230143	0301375
8	UNLOADING AUGER DRIVE	1	247782	0102216
9	GOVERNOR (GAS ENGINE)	1	266209	/
10	FAN AND ALTERNATOR (CAT DIESEL)	1	254084	0173234
10	FAN AND ALTERNATOR (GAS)	1	261472	/
10	FAN AND ALTERNATOR (FORD DIESEL)	1	576774	/
10	FAN AND ALTERNATOR (CAT DIESEL)	1	626654	0372240
11	ROTARY SCREEN DRIVE	1	126805	1400066
12	HEADER DRIVE	1	246980	0303317
13	CLEANING FAN DRIVE	1	284521	/
14	GROUND SPEED. HYDRO DRIVE	1	268612	0352336
14	GROUND SPEED. VARI-DRIVE	1	261001	0313269
15	MAIN DRIVE. POWER BAND (GAS AND CAT DIESEL)	1	246978	0325290
15	MAIN DRIVE. POWER BAND (FORD DIESEL)	1	576771	0325294
16	AIR CONDITIONING (GAS AND CAT DIESEL)	1	264557	0172235
16	AIR CONDITIONING (FORD DIESEL)	1	576776	/

NEW HOLLAND TR 75

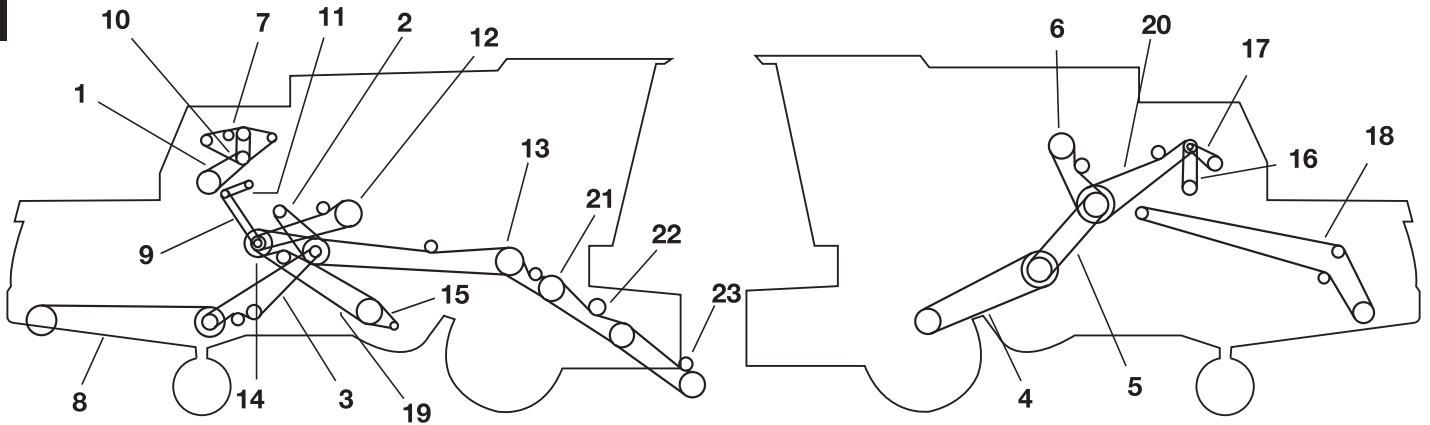

1	HYDRAULIC PUMP DRIVE (W/CAT)	1	248332	2001129
1	HYDRAULIC PUMP DRIVE (FORD)	1	576772	1901133
2	ROTARY VARI-DRIVE	1	717700	1413195
2	ROTORY VARI-DRIVE. HIGH SPEED ROTOR	1	637783	1513207
2	ROTOR VARI-DRIVE. STANDARD ROTOR	1	640143	0213197
3	STRAW CHOPPER. FRONT	1	619748	0302224
4	TRACTION HYDRO DRIVE. LOWER	1	716414	0102231
4	TRACTION HYDRO DRIVE. LOWER	1	634042	/
4	TRACTION HYDRO DRIVE. LOWER	1	636645	0313269
5	TRACTION HYDROSTATIC DRIVE. UPPER	1	716416	0302717
5	STANDARD TRACTION. VARI-DRIVE. UPPER	1	717700	1413195
5	STANDARD TRACTION. VARI-DRIVE. UPPER	1	254093	1913200
6	UNLOADING AUGER DRIVE	1	247782	0102216
7	ENGINE FAN (W/CAT)	1	647901	2743177
7	ENGINE FAN (FORD)	1	772654	0172228
8	STRAW CHOPPER. REAR	1	614040	0202305
9	ROTARY SCREEN. LOWER 65.75	1	610767	0372260
9	ROTARY SCREEN. LOWER 68.3	1	612305	1472264
10	WATER PUMP AND ALTERNATOR	1	772656	0272247
11	ROTARY SCREEN. UPPER	1	716254	0304325
12	CLEAN GRAIN ELEVATOR DRIVE	1	703747	2002190
13	HEADER DRIVE. 167-9/32	1	246980	0303317
13	HEADER DRIVE. 193	1	682008	0303365
14	DISCHARGE BEATER	1	621104	0102148
15	CLEANING FAN. VARI-DRIVE 46 SLOW DO	1	624398	0809104
15	CLEANING FAN. VARI-DRIVE 58 STANDARD	1	642569	/
16	HYDROSTATIC CHARGE PUMP	1	259477	1401129
17	AIR COMPRESSOR. 48	1	259346	1472227
17	AIR COMPRESSOR. 52.75	1	264557	0172235
17	AIR COMPRESSOR. 54.5	1	576776	/
18	STRAW CHOPPER DRIVE	1	246727	0301360
18	STRAW CHOPPER DRIVE	1	230143	0301375
19	SHAKER SHOE DRIVE	1	785415	0323282
20	MAIN SHAFT DRIVE. STANDARD TRACTION	1	795009	0357350
20	MAIN SHAFT DRIVE	1	576771	0325294
21	FEEDER DRIVE	1	620944	/
22	FIXED SPEED FEEDER DRIVE	1	621367	0702225
22	VARIABLE SPEED FEEDER DRIVE	1	630010	0312262
23	VARIABLE SPEED FEEDER DRIVE	1	699368	0357250
23	VARIABLE SPEED FEEDER DRIVE	1	632890	/



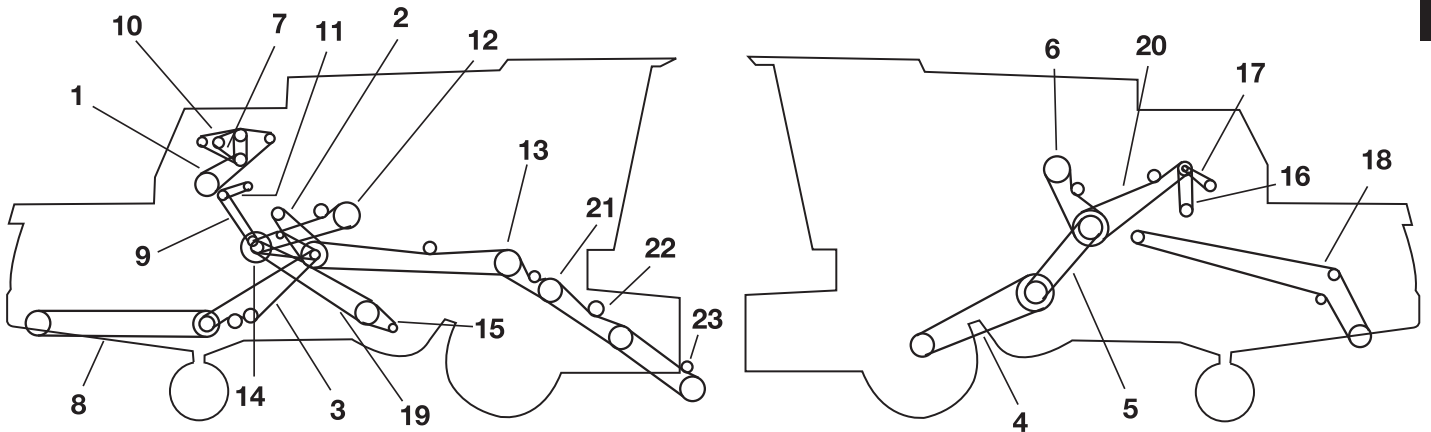

NEW HOLLAND TR 85

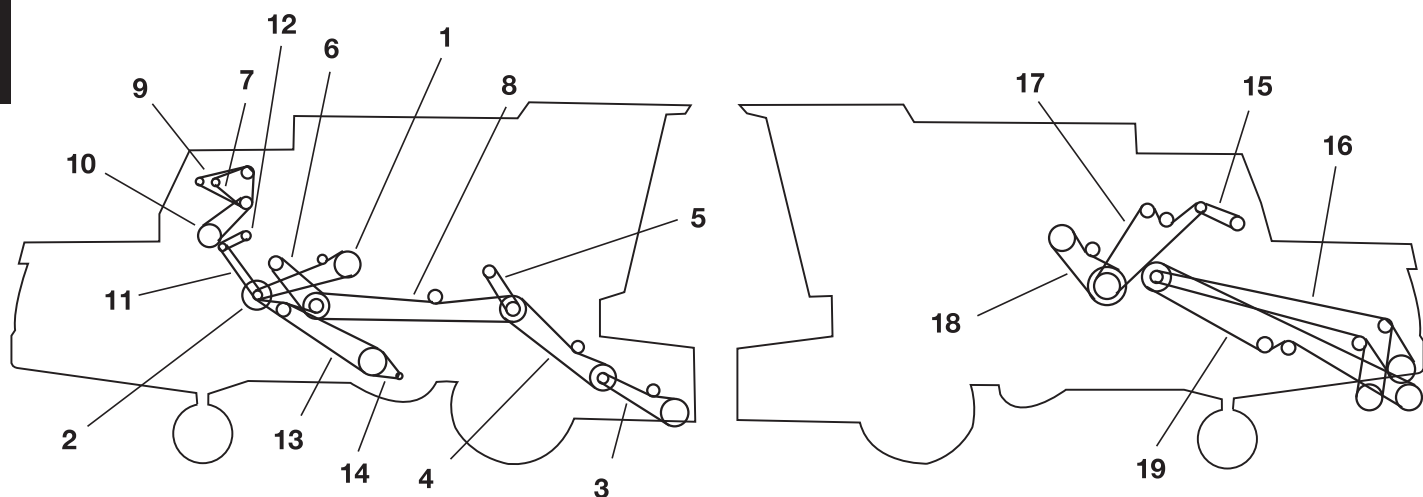

			OE	
2	ROTARY VARI-DRIVE. HIGH SPEED ROTOR	1	637783	1513207
2	ROTARY VARI-DRIVE	1	717700	1413195
2	ROTOR VARI-DRIVE. STANDARD ROTOR	1	640143	0213197
3	STRAW CHOPPER. FRONT	1	619748	0302224
4	TRACTION HYDRO DRIVE. LOWER	1	716414	0102231
4	TRACTION HYDRO DRIVE. LOWER	1	634042	/
4	TRACTION HYDRO DRIVE. LOWER	1	636645	0313269
5	TRACTION HYDROSTATIC DRIVE. UPPER	1	716416	0302717
5	STANDARD TRACTION. VARI-DRIVE. UPPER	1	717700	1413195
5	STANDARD TRACTION. VARI-DRIVE. UPPER	1	254093	1913200
6	UNLOADING AUGER DRIVE	1	247782	0102216
7	ENGINE FAN (W/CAT)	1	647901	2743177
7	ENGINE FAN (FORD)	1	772654	0172228
8	STRAW CHOPPER. REAR	1	614040	0202305
9	ROTARY SCREEN. LOWER 65.75	1	610767	0372260
9	ROTARY SCREEN. LOWER 68.3	1	612305	1472264
11	ROTARY SCREEN. UPPER	1	716254	0304325
12	CLEAN GRAIN ELEVATOR DRIVE	1	703747	2002190
13	HEADER DRIVE. 167-9/32	1	246980	0303317
13	HEADER DRIVE. 193	1	682008	0303365
14	DISCHARGE BEATER	1	621104	0102148
15	CLEANING FAN. VARI-DRIVE 46 SLOW DO	1	624398	0809104
15	CLEANING FAN. VARI-DRIVE 58 STANDARD	1	642569	/
16	HYDROSTATIC CHARGE PUMP	1	259477	1401129
17	AIR COMPRESSOR. 48	1	259346	1472227
17	AIR COMPRESSOR. 52.75	1	264557	0172235
17	AIR COMPRESSOR. 54.5	1	576776	/
18	STRAW CHOPPER DRIVE	1	246727	0301360
18	STRAW SPREADER DRIVE	1	230143	0301375
19	SHAKER SHOE DRIVE	1	785415	0323282
20	MAIN SHAFT DRIVE. STANDARD TRACTION	1	795009	0357350
20	MAIN SHAFT DRIVE	1	246978	0325290
21	FEEDER DRIVE	1	620944	/
22	FIXED SPEED FEEDER DRIVE	1	621367	0702225
22	VARIABLE SPEED FEEDER DRIVE	1	630010	0312262
23	VARIABLE SPEED FEEDER DRIVE	1	699368	0357250
23	VARIABLE SPEED FEEDER DRIVE	1	632890	/





NEW HOLLAND TR 86

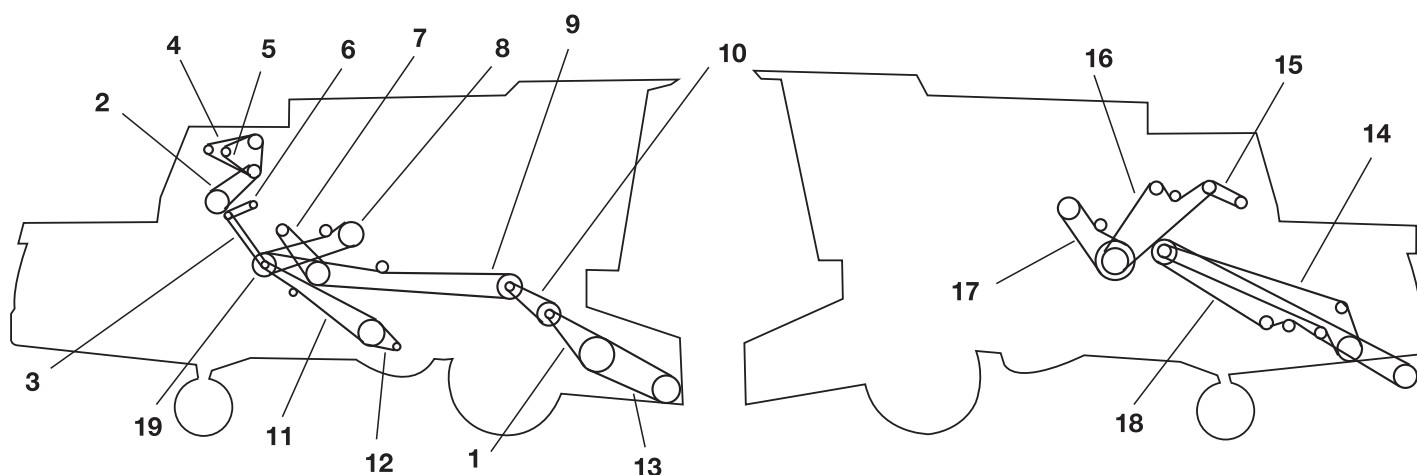

				
1	CLEAN GRAIN ELEVATOR DRIVE	1	703747	2002190
2	DISCHARGE BEATER DRIVE	1	617362	1423188
3	FEEDER DRIVE	1	699268	0357262
4	SMALL GRAIN SPECIAL	1	9613963	0324344
4	FIXED SPEED FEEDER DRIVE	1	621367	0702225
4	VARI-SPEED FEEDER	1	849514	0312262
5	HYDRAULIC REEL DRIVE PUMP DRIVE	1	244025	0201123
6	ROTOR VARI-DRIVE. HIGH SPEED	1	637783	1513207
6	ROTOR VARI-DRIVE. STANDARD	1	640143	0213197
7	ENGINE FAN. HYDRAULIC PUMP. SET OF 2	1	855676	0372260
7	ENGINE FAN. SET OF 2	1	647901	2743177
8	HEADER DRIVE	1	682008	0303365
9	ALTERNATOR. SET OF 2	1	572981	0172217
9	ALTERNATOR. SET OF 2	1	626654	0372240
10	HYDRAULIC PUMP. SET OF 2	1	855676	0372260
10	HYDRAULIC PUMP. SET OF 2	1	248332	2001129
11	ROTARY SCREEN DRIVE (PRIMARY)	1	610767	0372260
11	ROTARY SCREEN DRIVE (PRIMARY)	1	612305	1472264
12	ROTARY SCREEN (SECONDARY)	1	716254	0304325
13	SHAKER SHOE DRIVE	1	785415	0323282
14	CLEANING FAN. VARI-DRIVE 52	1	/	/
14	CLEANING FAN. VARI-DRIVE 58 STANDARD	1	792809	0310128
15	AIR CONDITIONING COMPRESSOR	1	259346	1472227
15	AIR CONDITIONING COMPRESSOR	1	577240	1472238
16	STRAW SPREADER DRIVE	1	230143	0301375
17	MAIN SHAFT DRIVE. HYDROSTATIC	1	797978	0357428
17	MAIN SHAFT DRIVE. HYDROSTATIC	1	788803	0357416
18	UNLOADING AUGER DRIVE	1	694982	1902206
19	STRAW CHOPPER DRIVE	1	618853	0323472





NEW HOLLAND TR 95



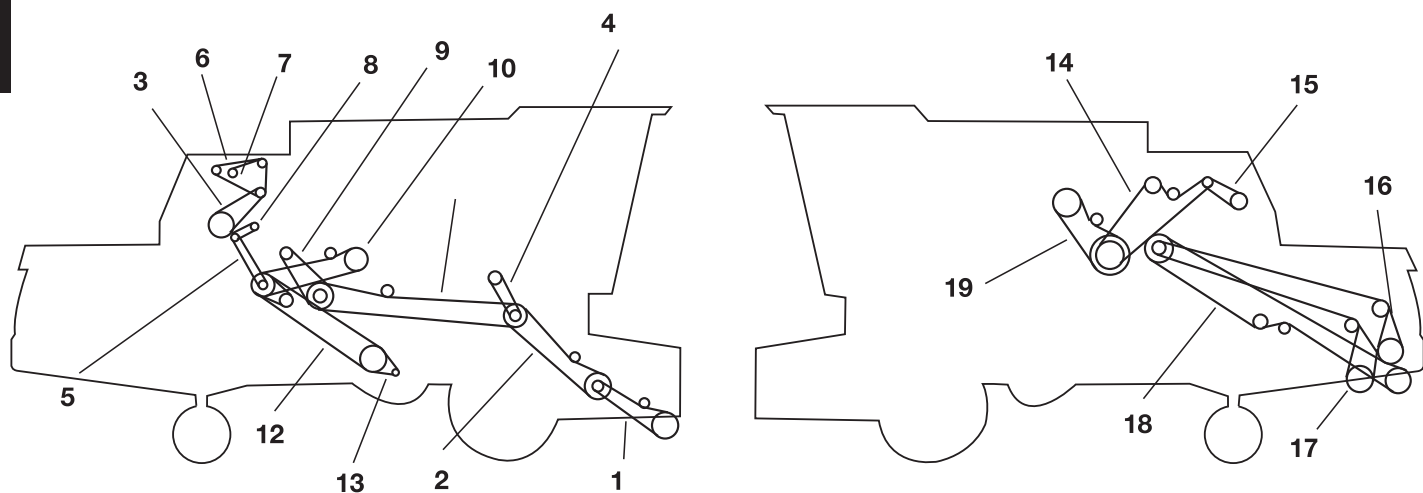



				
1	FIXED SPEED FEEDER	1	621367	0702225
1	VARI SPEED FEEDER	1	630010	0312262
2	HYDRAULIC PUMP	1	624650	1101149
3	ROTARY SCREEN DRIVE	1	615790	0300137
4	ALTERNATOR. WATER PUMP DRIVE	1	626654	0372240
5	ENGINE FAN DRIVE	1	758340	/
6	ALTERNATOR. SET OF 2	1	626657	0372240
6	ROTARY SCREEN SECONDARY DRIVE	1	716254	0304325
7	ROTOR DRIVE	1	692974	/
7	ROTOR DRIVE	1	692975	0351272
7	ROTOR DRIVE	1	787583	/
8	CLEAN GRAIN ELEVATOR DRIVE	1	230164	2002190
9	HEADER DRIVE	1	246980	0303317
9	ROTOR. VARI-DRIVE. HIGH SPEED	1	692975	0351272
10	FEEDER DRIVE. SET OF 3	1	620944	/
11	SHAKER SHOE DRIVE	1	774747	0323281
12	CLEANING FAN. VARI-DRIVE	1	710751	/
12	CLEANING FAN. VARI-DRIVE W/SLOW DOWN	1	710752	0710117
12	CLEANING FAN. VARI-DRIVE W/INT.SPD KIT	1	773300	2610134
13	STONEROLL DRIVE. SET OF 5	1	632890	/
14	STRAW CHOPPER BEATER DRIVE	1	230143	0301375
15	AIR CONDITIONING COMPRESSOR 48	1	259346	1472227
15	AIR CONDITIONING COMPRESSOR 52.75	1	264557	0172235
16	MAIN SHAFT AND HYDROSTATIC PUMP DRIVE	1	649035	0357416
16	MAIN SHAFT AND HYDROSTATIC PUMP DRIVE	1	638337	1513207
17	UNLOADING AUGER DRIVE	1	618805	0302220
18	STRAW SPREADER	1	618040	0301426

NEW HOLLAND TR 96







				
1	FEEDER DRIVE	1	699268	0357262
2	SMALL GRAIN SPECIAL. 3HB	1	9613963	0324344
2	FIXED SPEED FEEDER DRIVE	1	621367	0702225
2	VARI-SPEED FEEDER DRIVE	1	849514	0312262
2	VARI-SPEED FEEDER DRIVE	1	9601511	/
3	ENGINE FAN AND HYDRAULIC PUMP	1	855676	0372260
3	HYDRAULIC PUMP	1	624650	1101149
3	ENGINE FAN	1	768340	2043185
4	HYDRAULIC PUMP DRIVE	1	244025	0201123
5	ROTARY SCREEN DRIVE PRIMARY	1	615790	0300137
5	ROTARY SCREEN DRIVE PRIMARY	1	859063	/
6	ALTERNATOR. SET OF 2	1	572981	0172217
6	ALTERNATOR. SET OF 2	1	626654	0372240
6	ALTERNATOR. SET OF 2	1	626657	0372240
7	WATER PUMP DRIVE	1	592711	0372234
8	ROTARY SCREEN (SECONDARY)	1	716254	0304325
9	ROTOR. VARI-DRIVE. STANDARD	1	692974	/
9	ROTOR. VARI-DRIVE. HIGH SPEED	1	692975	0351272
10	CLEAN GRAIN ELEVATOR DRIVE (IMPROVED)	1	9604713	0323231
10	CLEAN GRAIN ELEVATOR DRIVE	1	230164	2002190
11	HEADER DRIVE	1	682008	0303365
12	SHAKER SHOE DRIVE	1	774747	0323281
13	CLEAN FAN. VARI-DRIVE 61.6 INT SPE	1	773300	2610134
13	CLEAN FAN. VARI-DRIVE 69.5 HIGH SPE	1	792811	0111152
14	MAIN SHAFT DRIVE. HYDROSTATIC	1	649035	0357416
14	MAIN SHAFT DRIVE. HYDROSTATIC	1	797979	0357428
15	AIR CONDITIONING COMPRESSOR	1	259346	1472227
15	AIR CONDITIONING COMPRESSOR	1	626657	0372240
16	STRAW SPREADER DRIVE	1	618040	0301426
17	STRAW CHOPPER. INFEEED DRUM DRIVE	1	230143	0301375
18	STRAW CHOPPER DRIVE	1	618853	0323472
19	UNLOADING AUGER DRIVE	1	618805	0302220

NEW HOLLAND TR 97





				
1	ENGINE FAN. HYDRAULIC PUMP (SET OF 2)	1	855676	0372260
2	ALTERNATOR. SET OF 2	1	572981	0172217
3	WATER PUMP DRIVE (FORD)	1	592711	0372234
4	ROTOR. VARI-DRIVE. STANDARD	1	692974	/
4	ROTOR. VARI-DRIVE. HIGH SPEED	1	692975	0351272
5	DISCHARGE BEATER	1	709806	/
6	CLEAN GRAIN ELEVATOR DRIVE IMPROVED	1	9604713	0323231
6	CLEAN GRAIN ELEVATOR DRIVE	1	230164	2002190
7	HEADER DRIVE	1	682008	0303365
8	HYDRAULIC REEL DRIVE PUMP	1	9609607	0301117
9	ROTARY SCREEN DRIVE (PRIMARY)	1	859063	/
10	SHAKER SHOE DRIVE	1	774747	0323281
12	FEEDER. DRIVE. BANDED	1	699268	0357262
13	FIXED SPEED FEEDER. SET OF 2	1	621367	0702225
14	VARI-SPEED FEEDER	1	9601511	/
15	MAIN SHAFT DRIVE. HYDROSTATIC. BANDED	1	797979	0357428
16	AIR CONDITIONING COMPRESSOR	1	626657	0372240
17	STRAW SPREADER DRIVE	1	618040	0301426
18	STRAW CHOPPER DRIVE	1	618853	0323472
19	STRAW CHOPPER. INFEED DRUM DRIVE	1	230143	0301375
20	UNLOADING AUGER DRIVE	1	618805	0302220

NEW HOLLAND TR 98

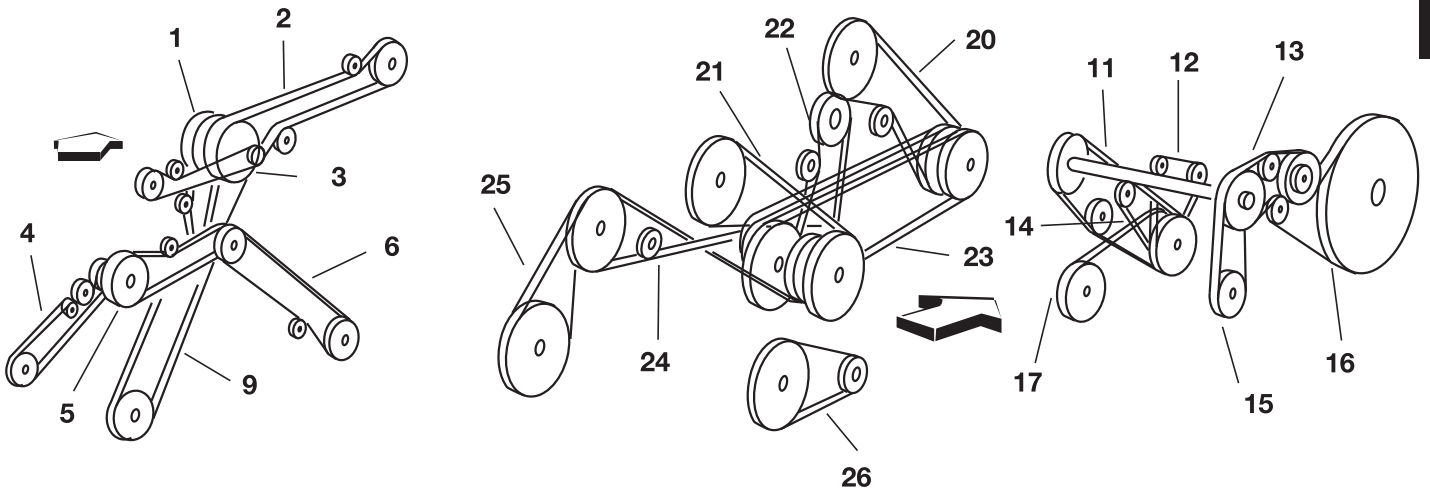
				
1	HYDRAULIC PUMP (SET OF 2)	1	773255	0272247
2	ALTERNATOR	1	86513664	0285301
3	WATER PUMP DRIVE	1	8652069	/
4	ROTOR. VARI-DRIVE. STANDARD	1	86518568	/
4	ROTOR. VARI-DRIVE. HIGH SPEED	1	86518659	/
5	DISCHARGE BEATER	1	86520042	1423198
6	CLEAN GRAIN ELEVATOR DRIVE IMPROVED	1	9604713	0323231
6	CLEAN GRAIN ELEVATOR DRIVE	1	230164	2002190
7	HEADER DRIVE	1	86503087	/
8	HYDRAULIC REEL DRIVE PUMP	1	9609607	0301117
9	ROTARY SCREEN DRIVE (PRIMARY)	1	859063	/
10	SHAKER SHOE DRIVE	1	774747	0323281
12	FEEDER. DRIVE. BANDED	1	699268	0357262
13	FIXED SPEED FEEDER	1	9613963	0324344
14	VARI-SPEED FEEDER	1	9601511	/
15	MAIN SHAFT DRIVE. HYDROSTATIC. BANDED	1	86514163	0357433
16	AIR CONDITIONING COMPRESSOR	1	577240	1472238
17	STRAW SPREADER DRIVE	1	618040	0301426
18	STRAW CHOPPER DRIVE	1	618853	0323472
19	STRAW CHOPPER. INFEEED DRUM DRIVE	1	230143	0301375
20	UNLOADING AUGER DRIVE	1	86514256	0302864

NEW HOLLAND TX 30





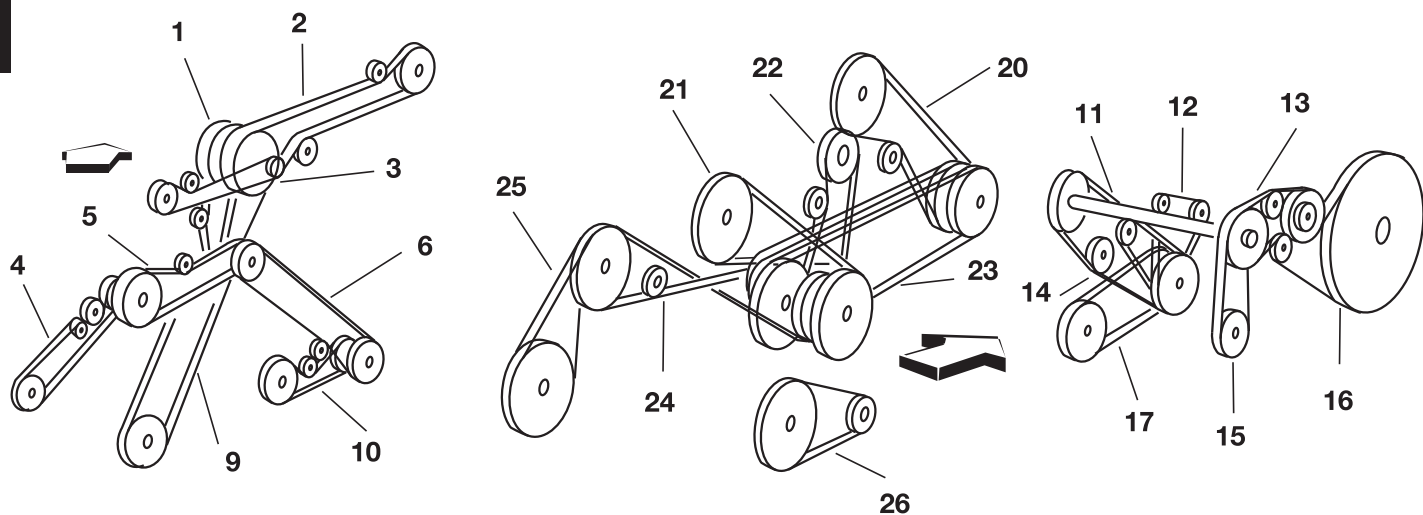

				
1	BEATER TO INTERMEDIATE DRIVE	1	80455865	1425218
2	ENGINE TO BEATER SHAFT - HYDROSTATIC DRIVE	1	80922872	0325361
2	ENGINE TO BEATER SHAFT - MECHANICAL DRIVE	1	80922911	0325362
3	UNLOADING AUGER ENGAGING / CODE 100	1	80445640	0302134
3	UNLOADING AUGER ENGAGING	1	89512971	0302134
4	STRAW ELEVATOR	1	80433746	0301351
5	BEATER TO STRAW ELEVATOR	1	80350236	0324284
6	CLEANING SHOE DRIVE BELT	1	80448794	1402307
9	GROUND SPEED VARIATOR	1	80440780	0313321
11	COOLING FAN DRIVE - INTERMEDIATE SHAFT	1	80913151	1201153
12	WATER PUMP DRIVE	1	80443634	0372223
13	ROTARY DUST SCREEN DRIVE	1	80913153	0372286
14	ALTERNATOR DRIVE	1	89501182	0372245
15	COMPRESSOR DRIVE	1	89506748	0372199
16	DUST SCREEN BELT	1	80923019	0300230
17	HYDRAULIC PUMP TO ENGINE	1	89508558	0372231
20	BEATER DRIVE BELT	1	89513984	0302200
21	ROTARY SEPARATOR DRIVE BELT	1	80754285	0502165
22	GRAIN STORAGE DRIVE	1	80433639	1601120
23	DRUM TO INTERMEDIATE DRIVE	1	80434160	0315204
24	STRAW WALKER INTERMEDIATE SHAFT DRIVE	1	80754389	1401208
25	STRAW WALKER DRIVE BELT	1	80754388	0201112
26	CLEANING FAN VARI - DRIVE BELT	1	89502654	0303144

NEW HOLLAND TX 32







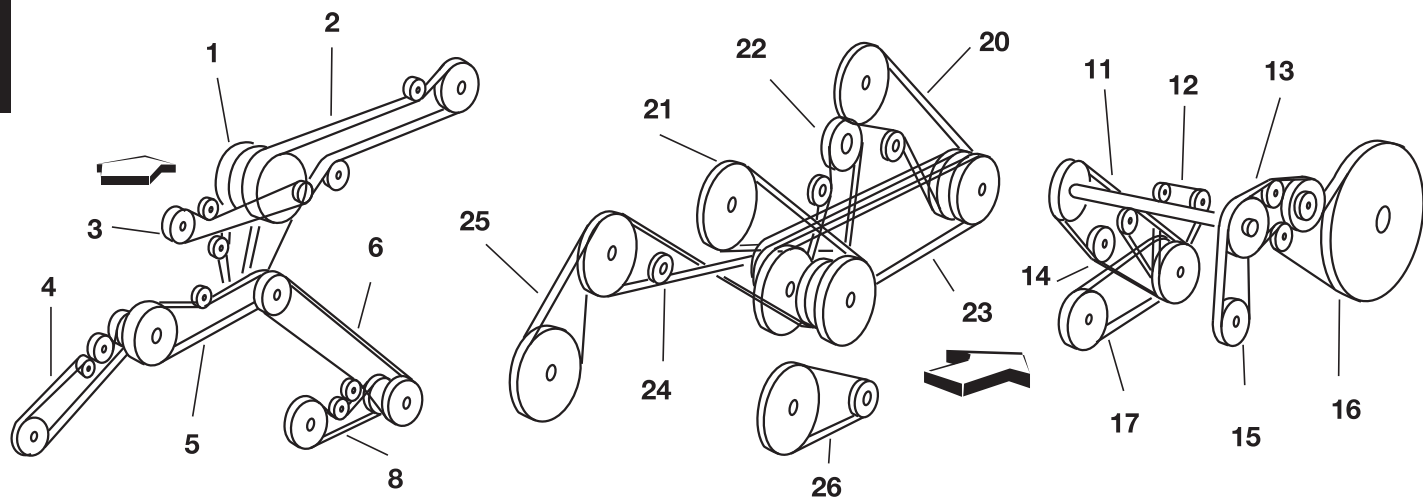

1	BEATER TO INTERMEDIATE DRIVE	1	80455865	1425218
2	ENGINE TO BEATER SHAFT - HYDROSTAT DRIVE	1	80922872	0325361
2	ENGINE TO BEATER SHAFT - MECHANICAL DRIVE	1	80922911	0325362
3	UNLOADING AUGER ENGAGING / CODE 129	1	80445640	0302134
3	UNLOADING AUGER ENGAGING	1	89512971	0302134
4	STRAW ELEVATOR SIDE	1	80433746	0301351
4	STRAW ELEVATOR SIDE	1	80454990	0324392
5	BEATER TO STRAW ELEVATOR	1	80434222	0323284
5	BEATER TO STRAW ELEVATOR	1	80350236	0324284
6	CLEANING SHOE DRIVE BELT / FIXED SHOE	1	80446780	2602304
6	CLEANING SHOE DRIVE BELT / SELF-LEVELLING	1	80448794	1402307
9	GROUND SPEED VARIATOR	1	80440780	0313321
10	ECCENTRIC SHAFT DRIVE / FIXED SHOE ONLY	1	80230164	2002190
11	COOLING FAN DRIVE - INTERMEDIATE SHAFT	1	80913151	1201153
12	WATER PUMP DRIVE	1	80443634	0372223
13	ROTARY DUST SCREEN DRIVE	1	80913153	0372286
14	ALTERNATOR DRIVE	1	89501182	0372245
15	COMPRESSOR DRIVE	1	89506748	0372199
16	DUST SCREEN DRIVE	1	80923019	0300230
17	HYDRAULIC PUMP TO ENGINE	1	89508558	0372231
20	BEATER DRIVE BELT / CODE 124	1	80186347	0302197
x	BEATER DRIVE BELT / CODE 123	1	89513984	0302200
21	ROTARY SEPARATOR DRIVE BELT	1	80754285	0502165
22	GRAIN STORAGE DRIVE	1	80433639	1601120
23	DRUM TO INTERMEDIATE SHAFT	1	80434160	0315204
24	STRAW WALKER INTERMEDIATE SHAFT DRIVE	1	80754389	1401208
25	STRAW WALKER DRIVE BELT	1	80754388	0201112
26	CLEANING FAN - CODE 111 / SELF-LEVELLING	1	89502654	0303144
26	CLEANING FAN - CODE 111 / FIXED SHOE	1	80919739	0303147
26	CLEANING FAN - CODE 110 / SELF-LEVELLING	1	80439832	0310153

NEW HOLLAND TX 34

				
1	UNLOADING AUGER ENGAGING	1	80445640	0302134
2	ENGINE TO BEATER SHAFT (HYDROSTATIC)	1	80922872	0325361
2	ENGINE TO BEATER SHAFT (MECHANICAL)	1	80922911	0325362
3	STRAW ELEVATOR DRIVE	1	80433746	0301351
3	STRAW ELEVATOR DRIVE	1	80454990	0324392
4	BEATER TO STRAW ELEVATOR	1	80434222	0323284
4	BEATER TO REINFORCED STRAW ELEVATOR	1	80350236	0324284
4	BEATER TO STRAW ELEVATOR	1	80743877	0225286
5	GROUND SPEED VARIATOR	1	80440780	0313321
6	BEATER TO INTERMEDIATE DRIVE	1	80455865	1425218
7	CLEANING SHOE DRIVE BELT	1	80448794	1402307
8		1	80923019	0300230
9	WATER PUMP & ALTERNATOR DRIVE	1	89501863	0372232
10		1	80913153	0372286
11		1	80443634	0372223
12		1	89501182	0372245
13	ROTARY SEPARATOR DRIVE BELT	1	80754285	0502165
14		1	80434047	0323229
15		1	80754165	0372204
16		1	80921698	0272247
17		1	80912771	/
18	STRAW WALKER DRIVE BELT	1	80754388	0201112
19	STRAW WALKER INTERMEDIATE SHAFT DRIVE	1	80754389	1401208
20	CLEANING FAN VARI-DRIVE BELT	1	80439832	0310153
21	GRAIN STORAGE DRIVE	1	80433639	1601120
22	DRUM TO INTERMEDIATE SHAFT	1	80434160	0315204

NEW HOLLAND TX 36



				
1	BEATER TO INTERMEDIATE DRIVE	1	80455865	1425218
2	ENGINE TO BEATER SHAFT	1	80922872	0325361
3	UNLOADING AUGER ENGAGING - CODE 130	1	80445640	0302134
3	UNLOADING AUGER ENGAGING - CODE 129	1	89512971	0302134
4	STRAW ELEVATOR SIDE	1	89504547	1401336
4	STRAW ELEVATOR SIDE	1	89504005	0324377
5	BEATER TO STRAW ELEVATOR	1	80434222	0323284
5	BEATER TO STRAW ELEVATOR	1	80350236	0324284
6	ECCENTRIC SHAFT - CODE 108 / BLOCKED FRAME	1	80230164	2002190
6	CLEANING SHOE DRIVE BELT	1	80448794	1402307
8	ECCENTRIC SHAFT - CODE 109 / BLOCKED FRAME	1	89513620	0202187
11	COOLING FAN DRIVE - INTERMEDIATE SHAFT	1	80913151	1201153
12	WATER PUMP DRIVE	1	80443634	0372223
13	ROTARY DUST SCREEN DRIVE	1	80913153	0372286
14	ALTERNATOR DRIVE	1	89501182	0372245
15	COMPRESSOR DRIVE	1	89506748	0372199
16	DUST SCREEN DRIVE	1	80923019	0300230
17	HYDRAULIC PUMP TO ENGINE	1	89508557	0372244
20	BEATER DRIVE BELT - CODE 118	1	80186347	0302197
20	BEATER DRIVE BELT - CODE 117	1	89513984	0302200
21	ROTARY SEPARATOR DRIVE BELT	1	80754285	0502165
22	GRAIN STORAGE DRIVE	1	80433639	1601120
23	DRUM TO INTERMEDIATE SHAFT	1	80434160	0315204
24	STRAW WALKER INTERMEDIATE SHAFT DRIVE	1	80754389	1401208
25	STRAW WALKER DRIVE BELT	1	80754388	0201112
26	CLEANING FAN VARI-DRIVE BELT	1	89502654	0303144

NEW HOLLAND TX 62 - TX 63 - TX 64 - TX 65 - TX 66 - TX 67 - TX 68

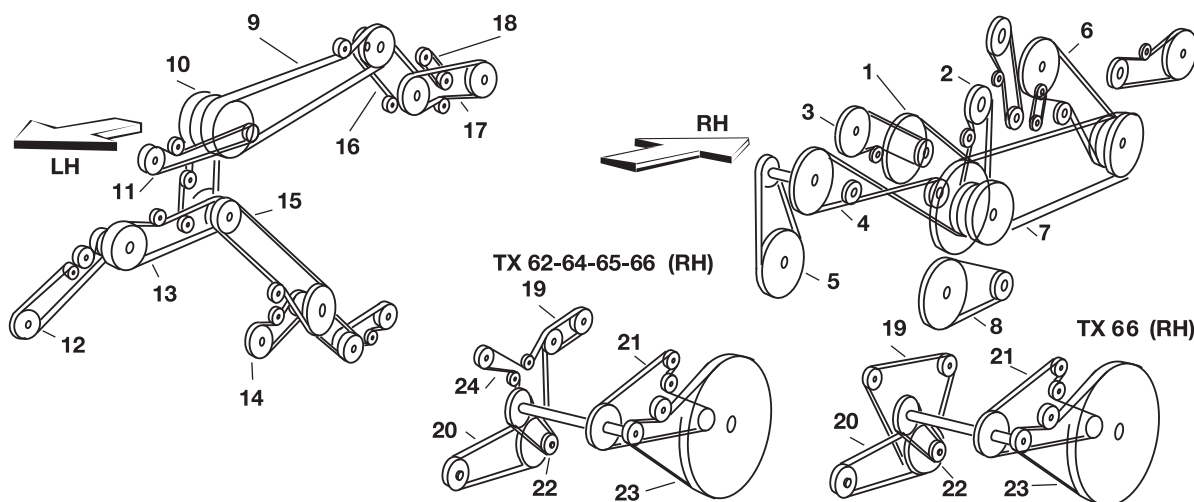

1		1	84015531	0102176
1		1	89850770	1102171
2		1	84015852	1601120
3		1	84015852	1601120
4		1	80754389	1401208
5		1	80754388	0201112
6		1	89513984	0302200
7		1	80434160	0315204
7		1	89832601	0315205
8	GRAS SEED. (SELF LEVELLING)	1	84023277	0303117
8	(SELL LEVELLING)	1	89502654	0303144
8	GRAS SEED. (FIXED SHOE) (BLOCKED FRAME)	1	84023278	0360230
9		1	80922911	0325362
9		1	89831571	0325365
10		1	80455865	1425218
11		1	89814069	0323173
12	(WITH LATERAL FLOTATION) (4HB)	1	89593400	0325436
12	(WITH LATERAL FLOTATION) (HC)	1	89593418	0302393
12	(HC)	1	89593440	0302400
12	(4HB)	1	89593464	0325442
13	(2HB)	1	80434222	0323284
13	(3HB)	1	89832309	0324284
14	(BLOCKED FRAME)	1	89513620	0202187
14	(FIXED SHOE)	1	80230164	2002190
15	(BLOCKED FRAME)	1	80446780	2602304
15	(FIXED SHOE)	1	80448794	1402307
16	(SELF LEVELLING)	1	84005417	1623311
16		1	84004444	0423318
17	STRAW CHOPPER	1	84004443	0323437
17	STRAW CHOPPER	1	84017621	0323448
18	CHAFF SPREADER	1	84018864	0101168
19		1	89835876	0372203
19		1	80754165	0372204
19		1	84007307	0372280
20		1	89839030	0372245
20		1	89835816	0172253
21		1	89833619	0372280
21		1	89514311	0372284
21		1	89817454	0372286
21		1	89817959	0372288
21		1	89850261	2099358
22		1	89833619	0372280
22		1	84007307	0372280
22		1	89514311	0372284
22		1	84000838	0372284
22		1	84037964	0372297
22		1	84041518	0372309
23		1	89818830	0300241
23		1	89835743	0399280
23		1	84022715	0399437
24		1	89835683	0385331
24		1	84036070	0385359