

NEW HOLLAND

1520

1	REEL DRIVE	80333255	1	1000775	4014486471847
2	KNIFE DRIVE	337415	1	1000625	4014486469738
2	KNIFE DRIVE	80337415	1	1000625	4014486469738
3	REEL DRIVE VARIABLE SPEED	80334065	1	1001403	4014486459098
4	INTERMEDIATE SHAFT - KNIFE	80330715	1	1000726	4014486471182
5	STRAW ELEVATOR DRIVE	80230059	1	1000654	4014486470178
8	HYDRAULIC PUMP DRIVE	80230043	1	1003400	4014486462906
10	ECCENTRIC DRIVE	80230061	1	1000717	4014486471076
11	STRAW WAIKER	80230046	1	1004468	4014486712124
12	FAN DRIVE (DEUTZ ENGINE)	80327040	1	1002267	4014486478358
14	FAN BELT (FORD ENG)	80371222	1	1002547	4014486494778
15	TAILINGS ELEVATOR	80230046	1	1004468	4014486712124
16	UNLOADING SYSTEM	80326298	1	1003489	4014486468427
17	DRUM DRIVE VARIABLE SPEED	80230078	1	1001509	4014486460254
18	FAN DRIVE VARIABLE SPEED	330204	1	1000243	4014486463613
18	FAN DRIVE VARIABLE SPEED	80330204	1	1000243	4014486463613

1530

1	REEL DRIVE	80333255	1	1000775	4014486471847
2	KNIFE DRIVE	80337415	1	1000625	4014486469738
3	REEL DRIVE VARIABLE SPEED	80334065	1	1001403	4014486459098
4	INTERMEDIATE KNIFE DRIVE	80330715	1	1000726	4014486471182
5	STRAW ELEVATOR DRIVE	80230073	1	1000904	4014486473506
6	ECCENTRIC SHAFT DRIVE	80230060	1	1003534	4014486470536
9	HYDRAULIC PUMP DRIVE	80230043	1	1003400	4014486462906
11	FAN DRIVE (DEUTZ ENGINE)	80336386	1	1000027	4014486483482
12	ALTERNATOR DRIVE (DEUTZ ENGINE)	386155	1	1000022	4014486483420
12	ALTERNATOR DRIVE (DEUTZ ENGINE)	80336426	1	1000020	4014486483390
12	ALTERNATOR DRIVE (DEUTZ ENGINE)	80386155	1	1000022	4014486483420
13	FAN BELT (FORD ENG)	80371222	1	1002547	4014486494778
14	ELEVATOR DRIVE GRAIN	80230059	1	1000654	4014486470178
16	TAILINGS ELEVATOR DRIVE	80230057	1	1000603	4014486469370
18	UNLOADING SYSTEM	80230103	1	1000881	4014486473216
19	DRUM DRIVE VARIABLE SPEED	80230078	1	1001509	4014486460254
20	FAN DRIVE VARIABLE SPEED	80230056	1	1003232	4014486518658
21	STRAW WAIKER - ECCENTRIC	80230108	1	1003452	4014486465617

1540

1	REEL DRIVE	80333255	1	1000775	4014486471847
2	KNIFE DRIVE	80337415	1	1000625	4014486469738
3	REEL DRIVE VARIABLE SPEED	80334065	1	1001403	4014486459098
4	SICKLE KNIFE DRIVE	80362500	2	1002788	4014486466201
5	DRUM DRIVE VARIABLE SPEED	80336784	1	1001506	4014486460216
7	MAIN SHAFT DRIVE	80323646	1	1001949	4014486490541
8	UNLOADING SYSTEM	80333958	1	1000715	4014486471052
9	DRUM DRIVE VARIABLE SPEED	80336784	1	1001506	4014486460216
12	ELEVATOR DRIVE GRAIN	80230164	1	1000622	4014486469660
12	GRAIN ELEVATOR DRIVE	80353584	1	1000734	4014486471281
14	TAILINGS ELEVATOR DRIVE	80323413	1	1000577	4014486468922
16	FAN DRIVE	80230059	1	1000654	4014486470178
19	DEUTZ ENGINE	80336386	1	1000027	4014486483482
19	FAN BELT (FORD ENG)	80371222	1	1002547	4014486494778
19	DEUTZ ENGINE	80386155	1	1000022	4014486483420

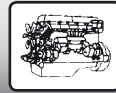
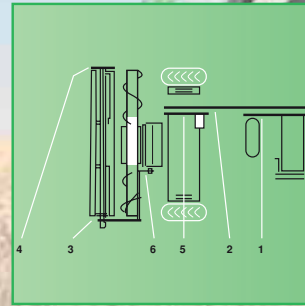
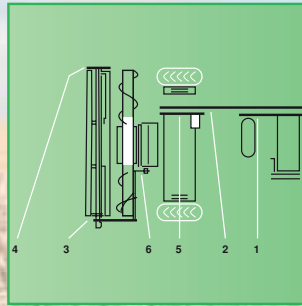
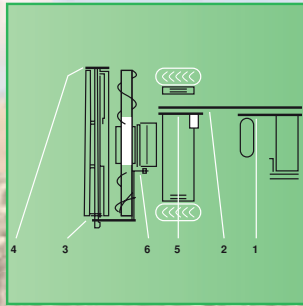
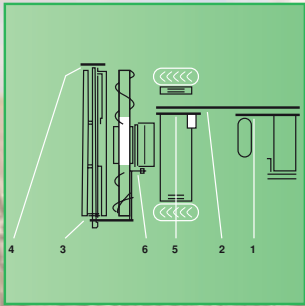

NEW HOLLAND

0	HYDRAULIC PUMP DRIVE	80350236	1	1003640	4014486489002
1545					
1	REEL DRIVE	80333255	1	1000775	4014486471847
2	KNIFE DRIVE	80337415	1	1000625	4014486469738
3	REEL DRIVE VARIABLE SPEED	80334065	1	1001403	4014486459098
5	STRAW ELEVATOR DRIVE	80230073	1	1000904	4014486473506
6	ECCENTRIC SHAFT DRIVE	80230060	1	1003534	4014486470536
9	HYDRAULIC PUMP DRIVE	80230043	1	1003400	4014486462906
11	STRAW WALKER DRIVE	80230108	1	1003452	4014486465617
12	FAN BELT (FORD ENG)	80371222	1	1002547	4014486494778
13	ELEVATOR DRIVE GRAIN	80230059	1	1000654	4014486470178
14	TAILINGS ELEVATOR DRIVE	80230057	1	1000603	4014486469370
16	DRUM DRIVE VARIABLE SPEED	80230078	1	1001509	4014486460254
17	FAN DRIVE VARIABLE SPEED	80230056	1	1003232	4014486518658
1550					
1	REEL DRIVE	80333255	1	1000775	4014486471847
2	KNIFE DRIVE	80337415	1	1000625	4014486469738
3	REEL DRIVE VARIABLE SPEED	80334065	1	1001403	4014486459098
4	INTERMEDIATE SHAFT KNIFE	80362500	2	1002788	4014486466201
5	DRUM DRIVE VARIABLE SPEED	80336784	1	1001506	4014486460216
6	HYDRAULIC PUMP DRIVE	80230043	1	1003400	4014486462906
7	MAIN SHAFT DRIVE	80323646	1	1001949	4014486490541
8	UNLOADING SYSTEM	80333958	1	1000715	4014486471052
9	DRUM DRIVE VARIABLE SPEED	80336784	1	1001506	4014486460216
10	GROUND SPEED DRIVE	80356025	1	1001525	4014486460445
11	GROUND SPEED VARIABLE DRIVE	80356025	1	1001525	4014486460445
14	ELEVATOR DRIVE GRAIN	80230164	1	1000622	4014486469660
16	TAILINGS ELEVATOR DRIVE	80323413	1	1000577	4014486468922
21	GRAIN ELEVATOR DRIVE	80353584	1	1000734	4014486471281
8030					
2	FORD ENGINE	80443634	1	1002543	4014486494723
6	DRUM DRIVE VARIABLE SPEED	80336784	1	1001506	4014486460216
7	FAN DRIVE VARIABLE SPEED	80230057	1	1000603	4014486469370
8	FAN DRIVE VARIABLE SPEED	80395955	1	1000555	4014486468496
9	STRAW WALKER - ECCENTRIC	80431784	1	1000328	4014486465587
13	ELEVATOR DRIVE UNIT	80422731	1	1000696	4014486470772
15	ECCENTRIC DRIVE	80387469	1	1000700	4014486470833
16	STRAW ELEVATOR DRIVE	80066232	1	1000690	4014486470697
17	HEADER DRIVE	80330715	1	1000726	4014486471182
8040					
2	ALTERNATOR AND WATERPUMP DRIVE	80443634	1	1002543	4014486494723
2	ALTERNATOR AND WATERPUMP DRIVE	80443636	2	1002935	4014486493443
5	DRUM DRIVE VARIABLE SPEED	80336784	1	1001506	4014486460216
7	CLEANING FAN DRIVE (UPPER)	80230057	1	1000603	4014486469370
8	FAN CLEANING DRIVE (LOWER)	80395955	1	1000555	4014486468496
9	STRAW WALKER DRIVE	80431784	1	1000328	4014486465587
13	ELEVATOR BOTTOM AUGER (GRAIN)	80422731	1	1000696	4014486470772
15	ECCENTRIC SHAFT DRIVE	80387469	1	1000700	4014486470833
16	STRAW ELEVATOR DRIVE	80066232	1	1000690	4014486470697
17	HEADER DRIVE	80330715	1	1000726	4014486471182
19	INTERMEDIATE SHAFT - FAN	80427456	1	1003351	4014486464603

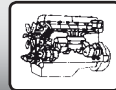
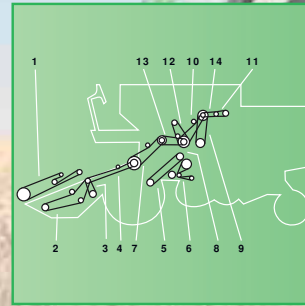
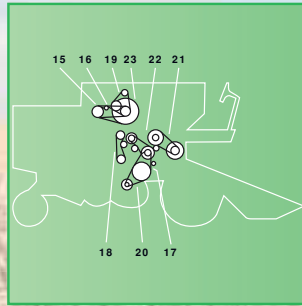
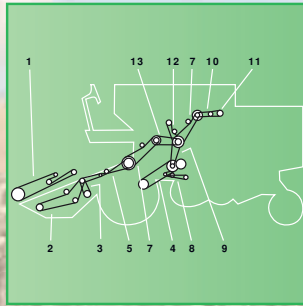
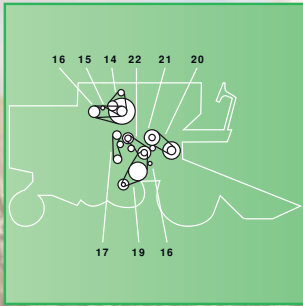

NEW HOLLAND

8060

1	REEL DRIVE	80333255	1	1000775	4014486471847
2	KNIFE DRIVE	80337415	1	1000625	4014486469738
3	REEL DRIVE VARIABLE SPEED	80334065	1	1001403	4014486459098
6	STRAW ELEVATOR DRIVE	80393326	1	1003323	4014486485677
7	DRUM DRIVE VARIABLE SPEED	80397297	1	1001858	4014486488937
8	STRAW WALKER DRIVE	80605529	1	1000366	4014486466287
12	INTERMEDIATE SHAFT - AUGER (GRAIN)	80410896	1	1000567	4014486468748
14	ALTERNATOR DRIVE (FORD 2704 ET)	80371222	1	1002547	4014486494778
15	FAN DRIVE	80399058	1	1002599	4014486496055
17	TAILINGS AUGER (SUPERIOR) (GRAIN)	80387469	1	1000700	4014486470833
18	FAN DRIVE	80378989	2	1002821	4014486463606
19	FAN DRIVE	80388280	1	1001410	4014486459173
20	DRUM DRIVE VARIABLE SPEED	80336784	1	1001506	4014486460216
21	BEATER DRIVE 8060 (330 = 4313001 - 4321999)	80396750	2	1002880	4014486468915
21	BEATER DRIVE 8060 (40 = 4322001 - ...)	80437033	2	1002878	4014486468991
22	INTERMEDIATE SHAFT - BEATER DRIVE	80395955	1	1000555	4014486468496
-	GROUND SPEED DRIVE	80230077	1	1001489	4014486459999
-	SPEED VARIATOR DRIVE	80356024	1	1001489	4014486459999
-	GROUND SPEED DRIVE (STANDARD SPEED)	80424318	1	1001467	4014486459777
-	BEATER DRUM DRIVE	80451481	1	1001946	4014486490480

8070

1	REEL DRIVE	80333255	1	1000775	4014486471847
2	KNIFE DRIVE	80337415	1	1000625	4014486469738
3	REEL DRIVE VARIABLE SPEED	80334065	1	1001403	4014486459098
5	GROUND SPEED VARIATOR DRIVE	80356025	1	1001525	4014486460445
6	GROUND SPEED DRIVE (STANDARD SPEED) - PULLEY DIAMETER 404 MM	80321559	1	1001512	4014486460308
7	STRAW ELEVATOR DRIVE	80393326	1	1003323	4014486485677
8	STRAW WALKER DRIVE	80605529	1	1000366	4014486466287
9	HYDROSTATIC PUMP DRIVE	80411543	1	1003662	4014486490718
10	DRUM DRIVE VARIABLE SPEED	80391650	1	1001977	4014486490947
12	INTERMEDIATE SHAFT - AUGER (GRAIN)	80410896	1	1000567	4014486468748
13	RETHRESHER DRIVE	80451481	1	1001946	4014486490480
15	FAN DRIVE (MERCEDES OM 401)	80384397	1	1004896	4014486740295
17	FAN DRIVE	80378989	2	1002821	4014486463606
18	TAILINGS ELEVATOR DRIVE	80387469	1	1000700	4014486470833
19	ALTERNATOR DRIVE (FORD 2704 ET)	80371222	1	1002547	4014486494778
20	FAN DRIVE VARIABLE SPEED	80388280	1	1001410	4014486459173
21	DRUM DRIVE VARIABLE SPEED	80387460	1	1001537	4014486460568
21	DRUM DRIVE VARIABLE SPEED	87621086	1	1001537	4014486460568
22	COUNTERSHAFT DRIVE	80396750	2	1002880	4014486468915
22	COUNTERSHAFT DRIVE	80437033	2	1002878	4014486468991
23	VARIATOR DRIVE	80395955	1	1000555	4014486468496

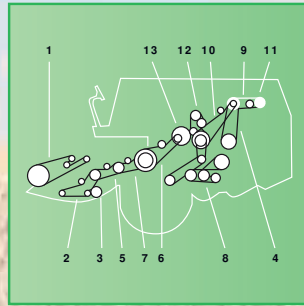
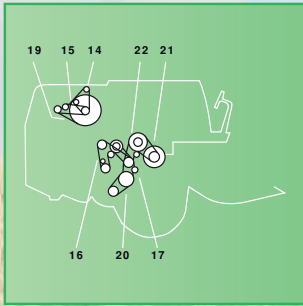

NEW HOLLAND

8080					
1	REEL DRIVE	80333255	1	1000775	4014486471847
2	KNIFE DRIVE	80337415	1	1000625	4014486469738
3	REEL DRIVE VARIABLE SPEED	80334065	1	1001403	4014486459098
4	HYDRO STATIC PUMP DRIVE	80411543	1	1003662	4014486490718
6	STRAW ELEVATOR DRIVE	80393326	1	1003323	4014486485677
7	HEADER DRIVE	80391142	2	1003838	4014486465563
7	HEADER DRIVE	80391143	2	1003838	4014486465563
8	STRAW WALKER DRIVE	80605529	1	1000366	4014486466287
10	DRUM DRIVE VARIABLE SPEED	80391650	1	1001977	4014486490947
12	INTERMEDIATE SHAFT - AUGER (GRAIN)	80410896	1	1000567	4014486468748
13	RETHRESHER DRIVE	80451481	1	1001946	4014486490480
14	ALTERNATOR DRIVE (MERCEDES ENGINE OM 421)	80432642	1	1003746	4014486495928
15	FAN DRIVE (MERCEDES OM 401)	80384397	1	1004896	4014486740295
17	FAN DRIVE	80378989	2	1002821	4014486463606
18	TAILINGS ELEVATOR DRIVE	80387469	1	1000700	4014486470833
20	FAN DRIVE VARIABLE SPEED	80388280	1	1001410	4014486459173
21	DRUM DRIVE VARIABLE SPEED	80387460	1	1001537	4014486460568
22	COUNTERSHAFT DRIVE	80396750	2	1002880	4014486468915
22	COUNTERSHAFT DRIVE	80437033	2	1002878	4014486468991
23	VARIATOR DRIVE	80395955	1	1000555	4014486468496

9630					
1	MAIN DRIVE	84017742	2	1001167	4014486491784
2	DRIVE	84026761	4	1002746	4014486461862
3	FAN DRIVE	84012975	2	1002087	4014486519129
4	ALTERNATOR DRIVE	84022807	1	1001132	4014486497168
5	COMPRESSOR DRIVE	80747177	1	1002582	4014486495638
5	COMPRESSOR DRIVE	89835815	1	1002588	4014486495812

9640					
1	MAIN DRIVE	84017742	2	1001167	4014486491784
2	DRIVE	84026761	4	1002746	4014486461862
3	FAN DRIVE	84012975	2	1002087	4014486519129
4	ALTERNATOR DRIVE	84022807	1	1001132	4014486497168
5	COMPRESSOR DRIVE	80747177	1	1002582	4014486495638
5	COMPRESSOR DRIVE	89835815	1	1002588	4014486495812

9645					
1	MAIN DRIVE	84017742	2	1001167	4014486491784
2	DRIVE	84026761	4	1002746	4014486461862
3	FAN DRIVE	84012975	2	1002087	4014486519129
4	ALTERNATOR DRIVE	84022807	1	1001132	4014486497168
5	COMPRESSOR DRIVE	80747177	1	1002582	4014486495638
5	COMPRESSOR DRIVE	89835815	1	1002588	4014486495812

NEW HOLLAND					
11		89814069	1	1001557	4014486484564
12		89593440	1	1000816	4014486472417
16		84004444	1	1001657	4014486486117
16	SELF LEVELING	84005417	1	1001655	4014486486094
		80445640	1	1000555	4014486468496
		89514989	1	1001679	4014486486483
		89817454	1	1000081	4014486484021

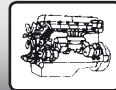

NEW HOLLAND

		89832309	1	1001861	4014486488975
		89850770	1	1003992	4014486518689
		K68073	1	1002465	4014486493504

1540 AL

1	REEL DRIVE	80333255	1	1000775	4014486471847
2	KNIFE DRIVE	80337415	1	1000625	4014486469738
3	REEL DRIVE VARIABLE SPEED	80334065	1	1001403	4014486459098
4	SICKIE KNIFE DRIVE	80362500	2	1002788	4014486466201
5	DRUM DRIVE VARIABLE SPEED	80336784	1	1001506	4014486460216
7	MAIN SHAFT DRIVE	80323646	1	1001949	4014486490541
8	UNLOADING SYSTEM	80333958	1	1000715	4014486471052
9	DRUM DRIVE VARIABLE SPEED	80336784	1	1001506	4014486460216
12	ELEVATOR DRIVE GRAIN	80230164	1	1000622	4014486469660
12	GRAIN ELEVATOR DRIVE	80353584	1	1000734	4014486471281
14	TAILINGS ELEVATOR DRIVE	80323413	1	1000577	4014486468922
16	FAN DRIVE	80230059	1	1000654	4014486470178
19	DEUTZ ENGINE	80336386	1	1000027	4014486483482
19	DEUTZ ENGINE	80386155	1	1000022	4014486483420
0	HYDRAULIC PUMP DRIVE	80350236	1	1003640	4014486489002

CR9060

2	STRAW ELEVATOR DRIVE 4HB	84072421	1	1002036	4014486491722
4	UNLOADING AUGER	87011585	1	1001636	4014486485844
5	MAIN DRIVE	87580097	1	1001978	4014486490954
6	CHOPPER DRIVE	87580100	1	1004127	4014486523096
7	BEATER DRIVE	87580099	1	1001627	4014486485660
8	BEATER DRIVE	86566287	1	1000532	4014486518818
9	SHAKER SHOE DRIVE - SELF-LEVELLING	84056913	2	1000265	4014486464207
10	CHOPPER DRIVE	87526022	1	1004128	4014486523102
11	AIR CONDITIONER UNIT: MOUNTING GROUP - WITH OIL HEATING	84818007	1	1002621	4014486480146
12	DRIVE, ROTARY SCREEN AND FAN	445930	1	1002074	4014486475623
13	DRIVE, ROTARY SCREEN AND FAN	84057085	1	1000175	4014486462036
14	DRIVE, ROTARY SCREEN AND FAN	87556830	1	1004157	4014486523362
16	FEEDER DRIVE	86589482	1	1001914	4014486489774
17	TAILINGS ELEVATORS, BOTTOM AUGER AND (RH)	84058339	2	1000200	4014486462388
18	GRAIN ELEVATOR, DRIVE	87319821	1	1004066	4014486519396
19	FAN VARDRIVE	84817627	1	1001135	4014486497199

CR9060 ELEVATION

2	STRAW ELEVATOR DRIVE 4HB	87545653	1	1004148	4014486523294
4	UNLOADING AUGER	87011585	1	1001636	4014486485844
5	MAIN DRIVE	87545651	1	1004150	4014486523317
6	CHOPPER DRIVE	87557181	1	1004139	4014486523195
7	BEATER DRIVE	87546479	1	1001636	4014486485844
8	BEATER DRIVE	87315599	1	1004066	4014486519396
9	SHAKER SHOE DRIVE - SELF-LEVELLING	87325684	2	1004179	4014486523034
10	CHOPPER DRIVE	87526022	1	1004128	4014486523102
11	AIR CONDITIONER UNIT: MOUNTING GROUP, UNTILBSN C 603	84818007	1	1002621	4014486480146
12	ROTARY SCREEN DRIVE AND FAN	87284244	2	1004162	4014486523409
13	DRIVE, ROTARY SCREEN AND FAN	84057085	1	1000175	4014486462036
13	DRIVE, ROTARY SCREEN AND FAN, UNTILBSN C 599	84057085	1	1000175	4014486462036
13	DRIVE, ROTARY SCREEN AND FAN, FROM ASN D 600	87664428	1	1004111	4014486522860
14	ALTERNATOR DRIVE	747177	1	1002582	4014486495638
16	HYDRAULIC FAN DRIVE	87636309	1	1004115	4014486522907

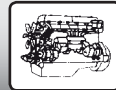

NEW HOLLAND

17	FEEDER DRIVE	86589482	1	1001914	4014486489774
18	TAILING S ELEVATORS, BOTTOM AUGER AND (RH)	84058339	2	1000200	4014486462388
19	GRAIN ELEVATOR, DRIVE	87319821	1	1004066	4014486519396

CR 9070 ELEVATION

2	STRAW ELEVATOR DRIVE 4HB	87545653	1	1004148	4014486523294
4	UNLOADING AUGER	87011585	1	1001636	4014486485844
5	MAIN DRIVE	87545651	1	1004150	4014486523317
6	CHOPPER DRIVE	87557181	1	1004139	4014486523195
7	BEATER DRIVE	87546479	1	1001636	4014486485844
8	BEATER DRIVE	87315599	1	1004066	4014486519396
9	SHAKER SHOE DRIVE - SELF-LEVELLING	87325684	2	1004179	4014486523034
10	CHOPPER DRIVE	87526022	1	1004128	4014486523102
11	AIR CONDITIONER UNIT: MOUNTING GROUP, UNTILBSN C 603	84818007	1	1002621	4014486480146
11	AIR CONDITIONER UNIT: MOUNTING GROUP - W/HEAT HEATING, FROM ASN D 604	84818008	1	1004045	4014486519280
12	ROTARY SCREEN DRIVE AND FAN	87284244	2	1004162	4014486523409
13	DRIVE, ROTARY SCREEN AND FAN, UNTILBSN C 599	84057085	1	1000175	4014486462036
13	DRIVE, ROTARY SCREEN AND FAN, ASN D 600	87664428	1	1004111	4014486522860
14	ALTERNATOR DRIVE	747177	1	1002582	4014486495638
15	ROTOR VARIATOR	87676816	1	No AP	
16	HYDRAULIC FAN DRIVE	87636309	1	1004115	4014486522907
17	FEEDER DRIVE	86589482	1	1001914	4014486489774
18	TAILING S ELEVATORS, BOTTOM AUGER AND (RH)	84058339	2	1000200	4014486462388
19	GRAIN ELEVATOR, DRIVE	87319821	1	1004066	4014486519396

CR 9080

2	STRAW ELEVATOR DRIVE 4HB	84072421	1	1002036	4014486491722
4	UNLOADING AUGER	87011585	1	1001636	4014486485844
5	MAIN DRIVE	87580097	1	1001978	4014486490954
6	CHOPPER DRIVE	87580100	1	1004127	4014486523096
7	BEATER DRIVE	87580099	1	1001627	4014486485660
8	BEATER DRIVE	86566287	1	1000532	4014486518818
9	SHAKER SHOE DRIVE - SELF-LEVELLING	84056913	2	1000265	4014486464207
10	CHOPPER DRIVE	87526022	1	1004128	4014486523102
11	AIR CONDITIONER UNIT: MOUNTING GROUP - W/HEAT HEATING	84818008	1	1004045	4014486519280
12	DRIVE, ROTARY SCREEN AND FAN	445930	1	1002074	4014486475623
13	DRIVE, ROTARY SCREEN AND FAN	84057085	1	1000175	4014486462036
14	DRIVE, ROTARY SCREEN AND FAN	87556830	1	1004157	4014486523362
15	ROTOR VARIATOR	87053803	1	No AP	
16	FEEDER DRIVE	86589482	1	1001914	4014486489774
17	TAILING S ELEVATORS, BOTTOM AUGER AND (RH)	84058339	2	1000200	4014486462388
18	GRAIN ELEVATOR, DRIVE	87319821	1	1004066	4014486519396
19	FAN VARDRIVE	84817627	1	1001135	4014486497199

CR 9080 ELEVATION

2	STRAW ELEVATOR DRIVE 4HB	87545653	1	1004148	4014486523294
4	UNLOADING AUGER	87011585	1	1001636	4014486485844
5	MAIN DRIVE	87545651	1	1004150	4014486523317
6	CHOPPER DRIVE	87557181	1	1004139	4014486523195
7	BEATER DRIVE	87546479	1	1001636	4014486485844
8	BEATER DRIVE	87315599	1	1004066	4014486519396
9	SHAKER SHOE DRIVE - SELF-LEVELLING	87325684	2	1004179	4014486523034
10	CHOPPER DRIVE	87526022	1	1004128	4014486523102
11	AIR CONDITIONER UNIT: MOUNTING GROUP, UNTILBSN C 603	84818007	1	1002621	4014486480146

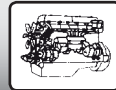

NEW HOLLAND

11	AIR CONDITIONER UNIT: MOUNTING GROUP - WITH HEATING, FROM ASN D 604	84818008	1	1004045	4014486519280
12	ROTARY SCREEN DRIVE AND FAN	87284244	2	1004162	4014486523409
13	ROTARY DUST SCREEN DRIVE	9513136	1	1004110	4014486522853
14	ALTERNATOR DRIVE	747177	1	1002582	4014486495638
16	HYDRAULIC FAN DRIVE	87636309	1	1004115	4014486522907
17	FEEDER DRIVE	86589482	1	1001914	4014486489774
18	TAILINGS ELEVATORS, BOTTOM AUGER AND (RH)	84058339	2	1000200	4014486462388
19	GRAIN ELEVATOR, DRIVE	87319821	1	1004066	4014486519396

CR 960					
2	STRAW ELEVATOR DRIVE 4HB	84072421	1	1002036	4014486491722
4	UNLOADING AUGER	87011585	1	1001636	4014486485844
5	MAIN DRIVE	87580097	1	1001978	4014486490954
6	CHOPPER DRIVE	84320963	1	1001646	4014486485981
7	BEATER DRIVE	87580099	1	1001627	4014486485660
8	BEATER DRIVE	86566287	1	1000532	4014486518818
9	SHAKER SHOE DRIVE - SELF-LEVELLING	84056913	2	1000265	4014486464207
10		84320963	1	1001646	4014486485981
12	DRIVE, ROTARY SCREEN AND FAN	445930	1	1002074	4014486475623
13	DRIVE, ROTARY SCREEN AND FAN	84057085	1	1000175	4014486462036
14	ALTERNATOR DRIVE	747177	1	1002582	4014486495638
16	FEEDER DRIVE	86589482	1	1001914	4014486489774
17	TAILINGS ELEVATORS, BOTTOM AUGER AND (RH)	84058339	2	1000200	4014486462388
18	GRAIN ELEVATOR, DRIVE	87319821	1	1004066	4014486519396
19	CLEANING FAN, FIXED SHOE, SIEVE FIXED	919739	1	1001136	4014486497205
19	FAN VARI-DRIVE	84817627	1	1001135	4014486497199

CR 980					
2	STRAW ELEVATOR DRIVE 4HB	84072421	1	1002036	4014486491722
4	UNLOADING AUGER	87011585	1	1001636	4014486485844
5	MAIN DRIVE	87580097	1	1001978	4014486490954
6	CHOPPER DRIVE	84320963	1	1001646	4014486485981
7	BEATER DRIVE	87580099	1	1001627	4014486485660
8	BEATER DRIVE	86566287	1	1000532	4014486518818
9	SHAKER SHOE DRIVE - SELF-LEVELLING	84056913	2	1000265	4014486464207
10		84320963	1	1001646	4014486485981
12	DRIVE, ROTARY SCREEN AND FAN	445930	1	1002074	4014486475623
13	DRIVE, ROTARY SCREEN AND FAN	84057085	1	1000175	4014486462036
14	ALTERNATOR DRIVE	747177	1	1002582	4014486495638
15	ROTOR VARIATOR	87053803	1	No AP	
16	FEEDER DRIVE	86589482	1	1001914	4014486489774
17	TAILINGS ELEVATORS, BOTTOM AUGER AND (RH)	84058339	2	1000200	4014486462388
18	GRAIN ELEVATOR, DRIVE	87319821	1	1004066	4014486519396
19	CLEANING FAN, FIXED SHOE, SIEVE FIXED	919739	1	1001136	4014486497205
19	FAN VARI-DRIVE	84817627	1	1001135	4014486497199

CR960					
	ALTERNATOR/ WATERPUMP	500371653	1	1004473	4014486712162

CS 520					
1	ALTERNATOR, WATERPUMP AND AIR COMPRESSOR	84817638	1	1003807	4014486483048
2	MAIN TRANSMISSION	84993120	1	1002011	4014486491418
5	CHOPPER DRIVE	84076421	1	1001705	4014486486827
6	CHOPPER DRIVE	84075955	1	1003347	4014486486285

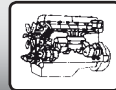

NEW HOLLAND

7	GRASS SEED EQUIPMENT	84452153	1	1004044	4014486518313
8	GRASS SEED EQUIPMENT	84452112	1	1004114	4014486522891
9	ELEVATOR BOTTOM DRIVE GRAIN	80422731	1	1000696	4014486470772
10	FAN DRIVE VARIABLE SPEED	84073979	1	1001421	4014486459289
11	SHAKER SHOE DRIVE	84015531	1	1000601	4014486469332
12	STRAW WALKER DRIVE	84073276	1	1000340	4014486465877
13	DRUM DRIVE	84072772	1	1001237	4014486491913
13	DRUM DRIVE (LOW DRUM SPEED)	84072815	1	1001952	4014486490572
14	ROTARY SEPARATOR DRIVE AND SHAFT	84073933	1	1000566	4014486468731
15	DRUM DRIVE VARIABLE SPEED	84035748	1	1001316	4014486497892
16	STRAW ELEVATOR DRIVE 3HB	84982278	1	1001697	4014486486735
16	STRAW ELEVATOR DRIVE 2HB (FOR CS520 ONLY)	84991234	1	1001922	4014486489903
17	HEADER DRIVE ENGAGING IDLER (2HB ONLY)	84446792	1	1003326	4014486486087
18	AIR COMPRESSOR - BLOW-OFF SYSTEM	84061465	1	1002586	4014486495775
19	ROTARY SCREEN AND FAN	84061465	1	1002586	4014486495775
19	ROTARY SCREEN AND FAN	84989965	1	1000169	4014486461954
20	HYDROSTATIC PUMP DRIVE (NOT FOR CS660)	84607712	1	1001850	4014486488838
21	HYDRAULIC PUMP DRIVE	80427456	1	1003351	4014486464603
22	UNLOADING AUGER DRIVE	84991836	1	1000653	4014486470161

CS 540

1	ALTERNATOR, WATERPUMP AND AIR COMPRESSOR	84817638	1	1003807	4014486483048
2	MAIN TRANSMISSION	84993120	1	1002011	4014486491418
5	CHOPPER DRIVE	84076421	1	1001705	4014486486827
6	CHOPPER DRIVE	84075955	1	1003347	4014486486285
7	GRASS SEED EQUIPMENT	84452153	1	1004044	4014486518313
8	GRASS SEED EQUIPMENT	84452112	1	1004114	4014486522891
9	ELEVATOR BOTTOM DRIVE GRAIN	80422731	1	1000696	4014486470772
10	FAN DRIVE VARIABLE SPEED	84073979	1	1001421	4014486459289
11	SHAKER SHOE DRIVE	84015531	1	1000601	4014486469332
12	STRAW WALKER DRIVE	84073276	1	1000340	4014486465877
13	DRUM DRIVE	84072772	1	1001237	4014486491913
13	DRUM DRIVE (LOW DRUM SPEED)	84072815	1	1001952	4014486490572
14	ROTARY SEPARATOR DRIVE AND SHAFT	84073933	1	1000566	4014486468731
15	DRUM DRIVE VARIABLE SPEED	84035748	1	1001316	4014486497892
16	STRAW ELEVATOR DRIVE 2HB (NOT FOR CS520)	84981586	1	1001720	4014486487022
16	STRAW ELEVATOR DRIVE 3HB	84982278	1	1001697	4014486486735
17	HEADER DRIVE ENGAGING IDLER (2HB ONLY)	84446792	1	1003326	4014486486087
17	HEADER DRIVE ENGAGING IDLER (3HB ONLY/ NOT CS520)	89817374	1	1001876	4014486489231
18	AIR COMPRESSOR - BLOW-OFF SYSTEM	84061465	1	1002586	4014486495775
19	ROTARY SCREEN AND FAN	84061465	1	1002586	4014486495775
19	ROTARY SCREEN AND FAN	84989965	1	1000169	4014486461954
20	HYDROSTATIC PUMP DRIVE (NOT FOR CS660)	84607712	1	1001850	4014486488838
21	HYDRAULIC PUMP DRIVE	80427456	1	1003351	4014486464603
22	UNLOADING AUGER DRIVE	84991836	1	1000653	4014486470161

CS 6050

2	STRAW ELEVATOR DRIVE, 2HB	84981586	1	1001720	4014486487022
2	STRAW ELEVATOR DRIVE, 3HB	84991234	1	1001922	4014486489903
3	HEADER DRIVE ENGAGING IDLER 2HB ONLY	84446792	1	1003326	4014486486087
3	HEADER DRIVE ENGAGING IDLER 3HB ONLY	89817374	1	1001876	4014486489231
4	DRUM VARIATOR	84035748	1	1001316	4014486497892
5	GRAIN TANK UNLOADING	84462590	1	1000653	4014486470161
6	MAIN DRIVE	84993120	1	1002011	4014486491418
7	HYDROSTATIC PUMP DRIVE	80427456	1	1003351	4014486464603

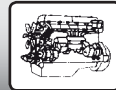

NEW HOLLAND

8	HYDRO STATIC PUMP DRIVE	84607712	1	1001850	4014486488838
9	STRAW WALKER DRIVE	87521887	1	1000341	4014486465884
10	GRAIN ELEVATOR BOTTOM AUGER	80422731	1	1000696	4014486470772
13	CHOPPER DRIVE	84075955	1	1003347	4014486486285
14	CHOPPER DRIVE	84076421	1	1001705	4014486486827
15	DRIVE, ROTARY SCREEN AND FAN	84061465	1	1002586	4014486495775
16	DRIVE, ROTARY SCREEN AND FAN	84989965	1	1000169	4014486461954
17	ALTERNATOR DRIVE	747177	1	1002582	4014486495638
18	DRUM DRIVE	84072772	1	1001237	4014486491913
18	DRUM DRIVE, ROTATION SPEED SLOW	84072815	1	1001952	4014486490572
19	STRAW SHAKER DRIVE	84817635	1	1000601	4014486469332
20	FAN VARDRIVE	84073979	1	1001421	4014486459289
21	ROTARY SEPARATOR DRIVE AND SHAFT	84073933	1	1000566	4014486468731
22		84075955	1	1003347	4014486486285
23		84076421	1	1001705	4014486486827

CS 6070

2	STRAW ELEVATOR DRIVE, 2HB	84981586	1	1001720	4014486487022
2	STRAW ELEVATOR DRIVE, 3HB	84991234	1	1001922	4014486489903
3	HEADER DRIVE ENGAGING IDLER 2HB ONLY	84446792	1	1003326	4014486486087
3	HEADER DRIVE ENGAGING IDLER 3HB ONLY	89817374	1	1001876	4014486489231
4	DRUM VARIATOR	84035748	1	1001316	4014486497892
5	GRAIN TANK UNLOADING	84462590	1	1000653	4014486470161
6	MAIN DRIVE	84993120	1	1002011	4014486491418
7	HYDRO STATIC PUMP DRIVE	80427456	1	1003351	4014486464603
8	HYDRO STATIC PUMP DRIVE	84607712	1	1001850	4014486488838
9	STRAW WALKER DRIVE	87521887	1	1000341	4014486465884
10	GRAIN ELEVATOR BOTTOM AUGER	80422731	1	1000696	4014486470772
13	CHOPPER DRIVE	84075955	1	1003347	4014486486285
14	CHOPPER DRIVE	84076421	1	1001705	4014486486827
15	DRIVE, ROTARY SCREEN AND FAN	84061465	1	1002586	4014486495775
16	DRIVE, ROTARY SCREEN AND FAN	84989965	1	1000169	4014486461954
17	ALTERNATOR DRIVE	747177	1	1002582	4014486495638
18	DRUM DRIVE	84072772	1	1001237	4014486491913
18	DRUM DRIVE, ROTATION SPEED SLOW	84072815	1	1001952	4014486490572
19	STRAW SHAKER DRIVE	84817635	1	1000601	4014486469332
20	FAN VARDRIVE	84073979	1	1001421	4014486459289
21	ROTARY SEPARATOR DRIVE AND SHAFT	84073933	1	1000566	4014486468731
22		84075955	1	1003347	4014486486285
23		84076421	1	1001705	4014486486827
25	CHAFF SPREADER	84790356	1	1004472	4014486712148

CS 6080

2	STRAW ELEVATOR DRIVE, 2HB	84981586	1	1001720	4014486487022
2	STRAW ELEVATOR DRIVE, 3HB	84991234	1	1001922	4014486489903
3	HEADER DRIVE ENGAGING IDLER 2HB ONLY	84446792	1	1003326	4014486486087
3	HEADER DRIVE ENGAGING IDLER 3HB ONLY	89817374	1	1001876	4014486489231
4	DRUM VARIATOR	84035748	1	1001316	4014486497892
5	GRAIN TANK UNLOADING	84462590	1	1000653	4014486470161
6	MAIN DRIVE	84993120	1	1002011	4014486491418
7	HYDRO STATIC PUMP DRIVE	80427456	1	1003351	4014486464603
8	HYDRO STATIC PUMP DRIVE	84607712	1	1001850	4014486488838
9	STRAW WALKER DRIVE	87521887	1	1000341	4014486465884
10	GRAIN ELEVATOR BOTTOM AUGER	80422731	1	1000696	4014486470772
13	CHOPPER DRIVE	84075955	1	1003347	4014486486285

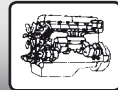

NEW HOLLAND

14	CHOPPER DRIVE	84076421	1	1001705	4014486486827
15	DRIVE, ROTARY SCREEN AND FAN	84061463	2	1004160	4014486523386
16	DRIVE, ROTARY SCREEN AND FAN	87374615	1	1004049	4014486518436
17	ALTERNATOR DRIVE	84817626	1	1002579	4014486495560
18	DRUM DRIVE	84072772	1	1001237	4014486491913
18	DRUM DRIVE, ROTATION SPEED SLOW	84072815	1	1001952	4014486490572
19	STRAW SHAKER DRIVE	84817635	1	1000601	4014486469332
20	FAN VARI-DRIVE	84073979	1	1001421	4014486459289
21	ROTARY SEPARATOR DRIVE AND SHAFT	84073933	1	1000566	4014486468731
22		84075955	1	1003347	4014486486285
23		84076421	1	1001705	4014486486827
25	CHAFF SPREADER	84790356	1	1004472	4014486712148

CS 6090

2	STRAW ELEVATOR DRIVE, 2HB	84981586	1	1001720	4014486487022
2	STRAW ELEVATOR DRIVE, 3HB	84991234	1	1001922	4014486489903
3	HEADER DRIVE ENGAGING IDLER 2HB ONLY	84446792	1	1003326	4014486486087
3	HEADER DRIVE ENGAGING IDLER 3HB ONLY	89817374	1	1001876	4014486489231
4	DRUM VARIATOR	84035748	1	1001316	4014486497892
5	GRAIN TANK UNLOADING	84462590	1	1000653	4014486470161
6	MAIN DRIVE	84993120	1	1002011	4014486491418
7	HYDROSTATIC PUMP DRIVE	80427456	1	1003351	4014486464603
8	HYDROSTATIC PUMP DRIVE	84607713	1	1001853	4014486488876
9	STRAW WALKER DRIVE	87521887	1	1000341	4014486465884
10	GRAIN ELEVATOR BOTTOM AUGER	80422731	1	1000696	4014486470772
13	CHOPPER DRIVE	84075955	1	1003347	4014486486285
14	CHOPPER DRIVE	84076421	1	1001705	4014486486827
15	DRIVE, ROTARY SCREEN AND FAN	84061463	2	1004160	4014486523386
16	DRIVE, ROTARY SCREEN AND FAN	87374615	1	1004049	4014486518436
17	ALTERNATOR DRIVE	84817626	1	1002579	4014486495560
18	DRUM DRIVE	84072772	1	1001237	4014486491913
18	DRUM DRIVE, ROTATION SPEED SLOW	84072815	1	1001952	4014486490572
19	STRAW SHAKER DRIVE	84817635	1	1000601	4014486469332
20	FAN VARI-DRIVE	84073979	1	1001421	4014486459289
21	ROTARY SEPARATOR DRIVE AND SHAFT	84073933	1	1000566	4014486468731
22		84075955	1	1003347	4014486486285
23		84076421	1	1001705	4014486486827
25	CHAFF SPREADER	84790356	1	1004472	4014486712148

CS 640

1	ALTERNATOR, WATERPUMP AND AIR COMPRESSOR	84817638	1	1003807	4014486483048
2	MAIN TRANSMISSION	84993120	1	1002011	4014486491418
3	CHAFF SPREADER DRIVE (FOR CS640 AND CS660 ONLY)	84790356	1	1004472	4014486712148
5	CHOPPER DRIVE	84076421	1	1001705	4014486486827
6	CHOPPER DRIVE	84075955	1	1003347	4014486486285
7	GRASS SEED EQUIPMENT	84452153	1	1004044	4014486518313
8	GRASS SEED EQUIPMENT	84452112	1	1004114	4014486522891
9	ELEVATOR BOTTOM DRIVE GRAIN	80422731	1	1000696	4014486470772
10	FAN DRIVE VARIABLE SPEED	84073979	1	1001421	4014486459289
11	SHAKER SHOE DRIVE	84015531	1	1000601	4014486469332
12	STRAW WALKER DRIVE	84073276	1	1000340	4014486465877
13	DRUM DRIVE	84072772	1	1001237	4014486491913
13	DRUM DRIVE (LOW DRUM SPEED)	84072815	1	1001952	4014486490572
14	ROTARY SEPARATOR DRIVE AND SHAFT	84073933	1	1000566	4014486468731
15	DRUM DRIVE VARIABLE SPEED	84035748	1	1001316	4014486497892

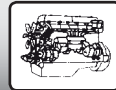

NEW HOLLAND

16	STRAW ELEVATOR DRIVE 2HB (NOT FOR CS520)	84981586	1	1001720	4014486487022
16	STRAW ELEVATOR DRIVE 3HB	84982278	1	1001697	4014486486735
17	HEADER DRIVE ENGAGING IDLER (2HB ONLY)	84446792	1	1003326	4014486486087
17	HEADER DRIVE ENGAGING IDLER (3HB ONLY/ NOT CS520)	89817374	1	1001876	4014486489231
18	AIR COMPRESSOR - BLOW-OFF SYSTEM	84061465	1	1002586	4014486495775
19	ROTARY SCREEN AND FAN	84061465	1	1002586	4014486495775
19	ROTARY SCREEN AND FAN	84989965	1	1000169	4014486461954
20	HYDROSTATIC PUMP DRIVE (NOT FOR CS660)	84607712	1	1001850	4014486488838
21	HYDRAULIC PUMP DRIVE	80427456	1	1003351	4014486464603
22	UNLOADING AUGER DRIVE	84991836	1	1000653	4014486470161

CS 660

1	ALTERNATOR, WATERPUMP AND AIR COMPRESSOR	84817638	1	1003807	4014486483048
2	MAIN TRANSMISSION	84993120	1	1002011	4014486491418
3	CHAFF SPREADER DRIVE (FOR CS640 AND CS660 ONLY)	84790356	1	1004472	4014486712148
5	CHOPPER DRIVE	84076421	1	1001705	4014486486827
6	CHOPPER DRIVE	84075955	1	1003347	4014486486285
7	GRASS SEED EQUIPMENT	84452153	1	1004044	4014486518313
8	GRASS SEED EQUIPMENT	84452112	1	1004114	4014486522891
9	ELEVATOR BOTTOM DRIVE GRAIN	80422731	1	1000696	4014486470772
10	FAN DRIVE VARIABLE SPEED	84073979	1	1001421	4014486459289
11	SHAKER SHOE DRIVE	84015531	1	1000601	4014486469332
12	STRAW WALKER DRIVE	84073276	1	1000340	4014486465877
13	DRUM DRIVE	84072772	1	1001237	4014486491913
13	DRUM DRIVE (LOW DRUM SPEED)	84072815	1	1001952	4014486490572
14	ROTARY SEPARATOR DRIVE AND SHAFT	84073933	1	1000566	4014486468731
15	DRUM DRIVE VARIABLE SPEED	84035748	1	1001316	4014486497892
16	STRAW ELEVATOR DRIVE 2HB (NOT FOR CS520)	84981586	1	1001720	4014486487022
16	STRAW ELEVATOR DRIVE 3HB	84982278	1	1001697	4014486486735
17	HEADER DRIVE ENGAGING IDLER (2HB ONLY)	84446792	1	1003326	4014486486087
17	HEADER DRIVE ENGAGING IDLER (3HB ONLY/ NOT CS520)	89817374	1	1001876	4014486489231
18	AIR COMPRESSOR - BLOW-OFF SYSTEM	84061465	1	1002586	4014486495775
19	ROTARY SCREEN AND FAN	84061465	1	1002586	4014486495775
19	ROTARY SCREEN AND FAN	84989965	1	1000169	4014486461954
20	HYDROSTATIC PUMP DRIVE (FOR CS660 ONLY)	84607713	1	1001853	4014486488876
21	HYDRAULIC PUMP DRIVE	80427456	1	1003351	4014486464603
22	UNLOADING AUGER DRIVE	84991836	1	1000653	4014486470161

CSX 7060

2	STRAW ELEVATOR DRIVE, 2HB	84981586	1	1001720	4014486487022
2	STRAW ELEVATOR DRIVE, 3HB	84991234	1	1001922	4014486489903
3	HEADER DRIVE ENGAGING IDLER 2HB ONLY	84446792	1	1003326	4014486486087
3	HEADER DRIVE ENGAGING IDLER 3HB ONLY	89817374	1	1001876	4014486489231
4	DRUM VARIATOR	84035748	1	1001316	4014486497892
5	GRAIN TANK UNLOADING	84462590	1	1000653	4014486470161
6	MAIN DRIVE	84993120	1	1002011	4014486491418
7	HYDROSTATIC PUMP DRIVE	80427456	1	1003351	4014486464603
8	HYDROSTATIC PUMP DRIVE	84607712	1	1001850	4014486488838
9	STRAW WALKER DRIVE	87521887	1	1000341	4014486465884
10	GRAIN ELEVATOR BOTTOM AUGER	80422731	1	1000696	4014486470772
13	CHOPPER DRIVE	84075955	1	1003347	4014486486285
14	CHOPPER DRIVE	84076421	1	1001705	4014486486827
15	DRIVE, ROTARY SCREEN AND FAN	84061463	2	1004160	4014486523386
16	DRIVE, ROTARY SCREEN AND FAN	87374615	1	1004049	4014486518436
17	ALTERNATOR DRIVE	84817626	1	1002579	4014486495560

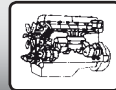

NEW HOLLAND

18	DRUM DRIVE	84072772	1	1001237	4014486491913
18	DRUM DRIVE, ROTATION SPEED SLOW	84072815	1	1001952	4014486490572
19	STRAW SHAKER DRIVE	84817635	1	1000601	4014486469332
20	FAN VARI-DRIVE	84073979	1	1001421	4014486459289
21	ROTARY SEPARATOR DRIVE AND SHAFT	84073933	1	1000566	4014486468731
22		84075955	1	1003347	4014486486285
23		84076421	1	1001705	4014486486827

CSX 7080

2	STRAW ELEVATOR DRIVE, 2 HB	84981586	1	1001720	4014486487022
2	STRAW ELEVATOR DRIVE, 3 HB	84991234	1	1001922	4014486489903
3	HEADER DRIVE ENGAGING IDLER 2 HB ONLY	84446792	1	1003326	4014486486087
3	HEADER DRIVE ENGAGING IDLER 3 HB ONLY	89817374	1	1001876	4014486489231
4	DRUM VARIATOR	84035748	1	1001316	4014486497892
5	GRAIN TANK UNLOADING	84462590	1	1000653	4014486470161
6	MAIN DRIVE	84993120	1	1002011	4014486491418
7	HYDROSTATIC PUMP DRIVE	80427456	1	1003351	4014486464603
8	HYDROSTATIC PUMP DRIVE	84607713	1	1001853	4014486488876
9	STRAW WALKER DRIVE	87521887	1	1000341	4014486465884
10	GRAIN ELEVATOR BOTTOM AUGER	80422731	1	1000696	4014486470772
13	CHOPPER DRIVE	84075955	1	1003347	4014486486285
14	CHOPPER DRIVE	84076421	1	1001705	4014486486827
15	DRIVE, ROTARY SCREEN AND FAN	84061463	2	1004160	4014486523386
16	DRIVE, ROTARY SCREEN AND FAN	87374615	1	1004049	4014486518436
17	ALTERNATOR DRIVE	84817626	1	1002579	4014486495560
18	DRUM DRIVE	84072772	1	1001237	4014486491913
18	DRUM DRIVE, ROTATION SPEED SLOW	84072815	1	1001952	4014486490572
19	STRAW SHAKER DRIVE	84817635	1	1000601	4014486469332
20	FAN VARI-DRIVE	84073979	1	1001421	4014486459289
21	ROTARY SEPARATOR DRIVE AND SHAFT	84073933	1	1000566	4014486468731
22		84075955	1	1003347	4014486486285
23		84076421	1	1001705	4014486486827
25	CHAFF SPREADER	84790356	1	1004472	4014486712148

CX 720

1	BEATER DRIVE	84045256	1	1000638	4014486469950
3	UNLOADING AUGER	84061293	1	1001634	4014486485820
4	MAIN DRIVE	84057914	1	1003844	4014486490893
5	CHOPPER DRIVE	84075345	1	1001636	4014486485844
6	CHOPPER DRIVE	84075635	1	1001687	4014486486612
7	INTERMEDIATE SHAFT FOR CLEANING DRIVE, WITH SLOPE COMPENSATION	84057392	1	1003337	4014486484847
8	SHAKER SHOE DRIVE, FIXED SHOE, WITH SLOPE COMPENSATION	84432785	1	1000680	4014486470543
9	STRAW WALKER DRIVE	84057482	1	1000400	4014486466638
10	SHAKER SHOE AND TAILINGS ELEVATOR DRIVE, WITH SLOPE COMPENSATION	84057874	1	1000699	4014486470826
11	TAILINGS ELEVATOR DRIVE, FIXED SHOE, WITH SLOPE COMPENSATION	84435035	1	1001644	4014486485967
12	DRUM VARIATOR	84035748	1	1001316	4014486497892
13	SHAKER SHOE DRIVE - SELF-LEVELLING	84056913	2	1000265	4014486464207
14	DRUM DRIVE	84061615	1	1001884	4014486489408
15	HEADER, DRIVE 3 HB	84061279	1	1001880	4014486489309
16	DRIVE, ROTARY SCREEN AND FAN, FOR HIGH SPEED ONLY	84057085	1	1000175	4014486462036
17	ROTOR AND VENTILATOR DRIVE	89835816	1	1002588	4014486495812
18	BLOW-OFF SYSTEM, AIR COMPRESSOR	84061465	1	1002586	4014486495775
19	DRIVE: ALTERNATOR, WATERPUMP AND AIR	84057710	1	1002690	4014486482959
20	GRAIN ELEVATOR, DRIVE	84073457	1	1000256	4014486464054
21	ROTARY SEPARATOR DRIVE AND SHAFT, -> C415	84057393	1	1001581	4014486484885

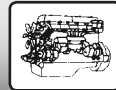

NEW HOLLAND

21	RO TARY SEPARATO R DRIVE AND SHAFT, D416 ->	84457079	1	1001583	4014486484908
24	TAILIN GS ELEVATO RS, BO TTOM AUGER AND (RH)DRIVE	84058339	2	1000200	4014486462388
25	FAN VARIDRIVE FO R FIXED SHO E ONIY	919739	1	1001136	4014486497205
25	FAN VARIDRIVE FO R SELF-LEVELLING ONIY	84817627	1	1001135	4014486497199
22-23	DRIVE STRAW ELEVATO R 4HB	84334995	1	1004196	4014486652567

CX 740

1	BEATER DRIVE	84045256	1	1000638	4014486469950
3	UNIO ADING AUGER	84061293	1	1001634	4014486485820
4	MAIN DRIVE	84057914	1	1003844	4014486490893
5	CHO PPER DRIVE	84075345	1	1001636	4014486485844
6	CHO PPER DRIVE	84075635	1	1001687	4014486486612
7	INTERMEDIATE SHAFT FO R CLEANING DRIVE, W ITH SLO PE CO MPENSATIO N	84057392	1	1003337	4014486484847
8	SHAKER SHO E DRIVE, FIXED SHO E, W ITHO UT SLO PE CO MPENSATIO N	84432785	1	1000680	4014486470543
9	STRAW WAIKER DRIVE	84057482	1	1000400	4014486466638
10	SHAKER SHO E AND TAILIN GS ELEVATO R DRIVE, W ITH SLO PE CO MPENSATIO N	84057874	1	1000699	4014486470826
11	TAILIN GS ELEVATO R DRIVE, FIXED SHO E, W ITHO UT SLO PE CO MPENSATIO N	84435035	1	1001644	4014486485967
12	DRUM VARIATO R	84035748	1	1001316	4014486497892
13	SHAKER SHO E DRIVE - SELF-LEVELLING	84056913	2	1000265	4014486464207
14	DRUM DRIVE	84061615	1	1001884	4014486489408
15	HEADER, DRIVE 3HB	84061279	1	1001880	4014486489309
16	DRIVE, RO TARY SCREEN AND FAN	84057085	1	1000175	4014486462036
17	RO TOR AND VEN TILATO R DRIVE	89835816	1	1002588	4014486495812
18	BLO W-O FF SYSTEM, AIR CO MPRESSOR	84061465	1	1002586	4014486495775
19	DRIVE : ALTERNATO R, WATERPUMP AND AIR	84057710	1	1002690	4014486482959
20	GRAIN ELEVATO R, DRIVE	84073457	1	1000256	4014486464054
21	RO TARY SEPARATO R DRIVE AND SHAFT, -> C415	84057393	1	1001581	4014486484885
21	RO TARY SEPARATO R DRIVE AND SHAFT, D416 ->	84457079	1	1001583	4014486484908
24	TAILIN GS ELEVATO RS, BO TTOM AUGER AND (RH)DRIVE	84058339	2	1000200	4014486462388
25	FAN VARIDRIVE FO R FIXED SHO E ONIY	919739	1	1001136	4014486497205
25	FAN VARIDRIVE FO R SELF-LEVELLING ONIY	84817627	1	1001135	4014486497199
22-23	DRIVE STRAW ELEVATO R 4HB	84334995	1	1004196	4014486652567

CX 760

1	BEATER DRIVE	84045256	1	1000638	4014486469950
3	UNIO ADING AUGER	84061293	1	1001634	4014486485820
4	MAIN DRIVE	84057914	1	1003844	4014486490893
5	CHO PPER DRIVE	84075345	1	1001636	4014486485844
6	CHO PPER DRIVE	84075635	1	1001687	4014486486612
7	INTERMEDIATE SHAFT FO R CLEANING DRIVE, W ITH SLO PE CO MPENSATIO N	84057392	1	1003337	4014486484847
8	SHAKER SHO E DRIVE, FIXED SHO E, W ITHO UT SLO PE CO MPENSATIO N	84432785	1	1000680	4014486470543
9	STRAW WAIKER DRIVE	84057482	1	1000400	4014486466638
10	SHAKER SHO E AND TAILIN GS ELEVATO R DRIVE, W ITH SLO PE CO MPENSATIO N	84057874	1	1000699	4014486470826
11	TAILIN GS ELEVATO R DRIVE, FIXED SHO E, W ITHO UT SLO PE CO MPENSATIO N	84435035	1	1001644	4014486485967
12	DRUM VARIATO R	84035748	1	1001316	4014486497892
13	SHAKER SHO E DRIVE - SELF-LEVELLING	84056913	2	1000265	4014486464207
14	DRUM DRIVE	84061615	1	1001884	4014486489408
15	HEADER, DRIVE 3HB	84061279	1	1001880	4014486489309
16	DRIVE, RO TARY SCREEN AND FAN	84057085	1	1000175	4014486462036
17	RO TOR AND VEN TILATO R DRIVE	89835816	1	1002588	4014486495812
18	BLO W-O FF SYSTEM, AIR CO MPRESSOR	84061465	1	1002586	4014486495775
19	DRIVE : ALTERNATO R, WATERPUMP AND AIR	84057710	1	1002690	4014486482959
20	GRAIN ELEVATO R, DRIVE	84073457	1	1000256	4014486464054
21	RO TARY SEPARATO R DRIVE AND SHAFT, -> C415	84057393	1	1001581	4014486484885
21	RO TARY SEPARATO R DRIVE AND SHAFT, D416 ->	84457079	1	1001583	4014486484908

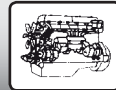

NEW HOLLAND

24	TAILING S ELEVATORS, BOTTOM AUGER AND (RH)DRIVE	84058339	2	1000200	4014486462388
25	FAN VARIDRIVE FOR FIXED SHOE ONLY	919739	1	1001136	4014486497205
25	FAN VARIDRIVE FOR SELF-LEVELLING ONLY	84817627	1	1001135	4014486497199
22-23	DRIVE STRAW ELEVATOR 4HB	84334995	1	1004196	4014486652567

CX 780

1	BEATER DRIVE	84045256	1	1000638	4014486469950
3	UNLOADING AUGER	84061293	1	1001634	4014486485820
4	MAIN DRIVE	84057914	1	1003844	4014486490893
5	CHOPPER DRIVE	84075345	1	1001636	4014486485844
6	CHOPPER DRIVE	84075635	1	1001687	4014486486612
7	INTERMEDIATE SHAFT FOR CLEANING DRIVE, WITH SLOPE COMPENSATION	84057392	1	1003337	4014486484847
8	SHAKER SHOE DRIVE, FIXED SHOE, WITH SLOPE COMPENSATION	84432785	1	1000680	4014486470543
9	STRAW WALKER DRIVE	84057482	1	1000400	4014486466638
10	SHAKER SHOE AND TAILING S ELEVATOR DRIVE, WITH SLOPE COMPENSATION	84057874	1	1000699	4014486470826
11	TAILING S ELEVATOR DRIVE, FIXED SHOE, WITH SLOPE COMPENSATION	84435035	1	1001644	4014486485967
12	DRUM VARIATOR	84035748	1	1001316	4014486497892
13	SHAKER SHOE DRIVE - SELF-LEVELLING	84056913	2	1000265	4014486464207
14	DRUM DRIVE	84061615	1	1001884	4014486489408
15	HEADER, DRIVE 3HB	84061279	1	1001880	4014486489309
16	DRIVE, ROTARY SCREEN AND FAN	84057085	1	1000175	4014486462036
17	ROTOR AND VENTILATOR DRIVE	89835816	1	1002588	4014486495812
18	BLOW-OFF SYSTEM, AIR COMPRESSOR	84061465	1	1002586	4014486495775
19	DRIVE: ALTERNATOR, WATERPUMP AND AIR	84057710	1	1002690	4014486482959
20	GRAIN ELEVATOR, DRIVE	84073457	1	1000256	4014486464054
21	ROTARY SEPARATOR DRIVE AND SHAFT, -> C415	84057393	1	1001581	4014486484885
21	ROTARY SEPARATOR DRIVE AND SHAFT, D416 ->	84457079	1	1001583	4014486484908
24	TAILING S ELEVATORS, BOTTOM AUGER AND (RH)DRIVE	84058339	2	1000200	4014486462388
25	FAN VARIDRIVE FOR FIXED SHOE ONLY	919739	1	1001136	4014486497205
25	FAN VARIDRIVE FOR SELF-LEVELLING ONLY	84817627	1	1001135	4014486497199
22-23	DRIVE STRAW ELEVATOR 4HB	84334995	1	1004196	4014486652567

CX 8030

1	BEATER DRIVE	84045256	1	1000638	4014486469950
3	UNLOADING AUGER	84061293	1	1001634	4014486485820
4	MAIN DRIVE	84057914	1	1003844	4014486490893
5	CHOPPER DRIVE	84075345	1	1001636	4014486485844
6	CHOPPER DRIVE	87339998	1	1004042	4014486519464
7	INTERMEDIATE SHAFT FOR CLEANING DRIVE, WITH SLOPE COMPENSATION	84057392	1	1003337	4014486484847
8	SHAKER SHOE DRIVE, FIXED SHOE, WITH SLOPE COMPENSATION	84432785	1	1000680	4014486470543
9	STRAW WALKER DRIVE	84057482	1	1000400	4014486466638
10	SHAKER SHOE AND TAILING S ELEVATOR DRIVE, WITH SLOPE COMPENSATION	84057874	1	1000699	4014486470826
11	TAILING S ELEVATOR DRIVE, FIXED SHOE, WITH SLOPE COMPENSATION	84435035	1	1001644	4014486485967
12	DRUM VARIATOR	84035748	1	1001316	4014486497892
13	SHAKER SHOE DRIVE - SELF-LEVELLING	84056913	2	1000265	4014486464207
14	DRUM DRIVE WITH REDUCTOR	84061615	1	1001884	4014486489408
15	HEADER, DRIVE 3HB	84061279	1	1001880	4014486489309
16	DRIVE, ROTARY SCREEN AND FAN	84057085	1	1000175	4014486462036
17	ROTOR AND VENTILATOR DRIVE	89835816	1	1002588	4014486495812
18	DRIVE, ROTARY SCREEN AND FAN	84061465	1	1002586	4014486495775
19	DRIVE: ALTERNATOR, WATERPUMP AND AIR	84057710	1	1002690	4014486482959
20	GRAIN ELEVATOR, DRIVE	84073457	1	1000256	4014486464054
21	ROTARY SEPARATOR DRIVE AND SHAFT	84457079	1	1001583	4014486484908
24	TAILING S ELEVATORS, BOTTOM AUGER AND (RH)	84058339	2	1000200	4014486462388
25	FAN VARIDRIVE FOR FIXED SHOE ONLY	919739	1	1001136	4014486497205

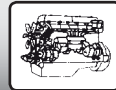

NEW HOLLAND

25	FAN VARIDRIVE FOR SELF-LEVELLING ONLY	84817627	1	1001135	4014486497199
22-23	DRIVE STRAW ELEVATOR 4HB	84334995	1	1004196	4014486652567

CX 8040

1	BEATER DRIVE	84045256	1	1000638	4014486469950
3	UNLOADING AUGER	84061293	1	1001634	4014486485820
4	MAIN DRIVE	84057914	1	1003844	4014486490893
5	CHOPPER DRIVE	84075345	1	1001636	4014486485844
6	CHOPPER DRIVE	87339998	1	1004042	4014486519464
7	INTERMEDIATE SHAFT FOR CLEANING DRIVE, WITH SLOPE COMPENSATION	84057392	1	1003337	4014486484847
8	SHAKER SHOE DRIVE, FIXED SHOE, WITH SLOPE COMPENSATION	84432785	1	1000680	4014486470543
9	STRAW WALKER DRIVE	84057482	1	1000400	4014486466638
10	SHAKER SHOE AND TAILINGS ELEVATOR DRIVE, WITH SLOPE COMPENSATION	84057874	1	1000699	4014486470826
11	TAILINGS ELEVATOR DRIVE, FIXED SHOE, WITH SLOPE COMPENSATION	84435035	1	1001644	4014486485967
12	DRUM VARIATOR	84035748	1	1001316	4014486497892
13	SHAKER SHOE DRIVE - SELF-LEVELLING	84056913	2	1000265	4014486464207
14	DRUM DRIVE WITH SLOPE REDUCTOR	84061615	1	1001884	4014486489408
15	HEADER, DRIVE 3HB	84061279	1	1001880	4014486489309
16	DRIVE, ROTARY SCREEN AND FAN	84057085	1	1000175	4014486462036
17	ROTOR AND VENTILATOR DRIVE	89835816	1	1002588	4014486495812
18	DRIVE, ROTARY SCREEN AND FAN	84061465	1	1002586	4014486495775
19	DRIVE: ALTERNATOR, WATERPUMP AND AIR	84057710	1	1002690	4014486482959
20	GRAIN ELEVATOR, DRIVE	84073457	1	1000256	4014486464054
21	ROTARY SEPARATOR DRIVE AND SHAFT	84457079	1	1001583	4014486484908
24	TAILINGS ELEVATORS, BOTTOM AUGER AND (RH)	84058339	2	1000200	4014486462388
25	FAN VARIDRIVE FOR FIXED SHOE ONLY	919739	1	1001136	4014486497205
25	FAN VARIDRIVE FOR SELF-LEVELLING ONLY	84817627	1	1001135	4014486497199
22-23	DRIVE STRAW ELEVATOR 4HB	84334995	1	1004196	4014486652567

CX 8050

1	BEATER DRIVE	84045256	1	1000638	4014486469950
3	UNLOADING AUGER	84061293	1	1001634	4014486485820
4	MAIN DRIVE	84057914	1	1003844	4014486490893
5	CHOPPER DRIVE	84075345	1	1001636	4014486485844
6	CHOPPER DRIVE	87339998	1	1004042	4014486519464
7	INTERMEDIATE SHAFT FOR CLEANING DRIVE, WITH SLOPE COMPENSATION	84057392	1	1003337	4014486484847
8	SHAKER SHOE DRIVE, FIXED SHOE, WITH SLOPE COMPENSATION	84432785	1	1000680	4014486470543
9	STRAW WALKER DRIVE	84057482	1	1000400	4014486466638
10	SHAKER SHOE AND TAILINGS ELEVATOR DRIVE, WITH SLOPE COMPENSATION	84057874	1	1000699	4014486470826
11	TAILINGS ELEVATOR DRIVE, FIXED SHOE, WITH SLOPE COMPENSATION	84435035	1	1001644	4014486485967
12	DRUM VARIATOR	84035748	1	1001316	4014486497892
13	SHAKER SHOE DRIVE - SELF-LEVELLING	84056913	2	1000265	4014486464207
14	DRUM DRIVE WITH SLOPE REDUCTOR	84061615	1	1001884	4014486489408
15	HEADER, DRIVE 3HB	84061279	1	1001880	4014486489309
16	DRIVE, ROTARY SCREEN AND FAN	84057085	1	1000175	4014486462036
17	ROTOR AND VENTILATOR DRIVE	89835816	1	1002588	4014486495812
18	DRIVE, ROTARY SCREEN AND FAN	84061465	1	1002586	4014486495775
19	DRIVE: ALTERNATOR, WATERPUMP AND AIR	84057710	1	1002690	4014486482959
20	GRAIN ELEVATOR, DRIVE	84073457	1	1000256	4014486464054
21	ROTARY SEPARATOR DRIVE AND SHAFT	84457079	1	1001583	4014486484908
24	TAILINGS ELEVATORS, BOTTOM AUGER AND (RH)	84058339	2	1000200	4014486462388
25	FAN VARIDRIVE FOR FIXED SHOE ONLY	919739	1	1001136	4014486497205
25	FAN VARIDRIVE FOR SELF-LEVELLING ONLY	84817627	1	1001135	4014486497199
22-23	DRIVE STRAW ELEVATOR 4HB	84334995	1	1004196	4014486652567

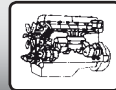

NEW HOLLAND

CX 8060

1	BEATER DRIVE	84045256	1	1000638	4014486469950
3	UNIO ADING AUGER	84061293	1	1001634	4014486485820
4	MAIN DRIVE	84057914	1	1003844	4014486490893
5	CHOPPER DRIVE	84075345	1	1001636	4014486485844
6	CHOPPER DRIVE	87339998	1	1004042	4014486519464
7	INTERMEDIATE SHAFT FOR CLEANING DRIVE, WITH SLOPE COMPENSATION	84057392	1	1003337	4014486484847
8	SHAKER SHOE DRIVE, FIXED SHOE, WITH SLOPE COMPENSATION	84432785	1	1000680	4014486470543
9	STRAW WALKER DRIVE	84057482	1	1000400	4014486466638
10	SHAKER SHOE AND TAILING S ELEVATOR DRIVE, WITH SLOPE COMPENSATION	84057874	1	1000699	4014486470826
11	TAILING S ELEVATOR DRIVE, FIXED SHOE, WITH SLOPE COMPENSATION	84435035	1	1001644	4014486485967
12	DRUM VARIATOR	84035748	1	1001316	4014486497892
13	SHAKER SHOE DRIVE - SELF-LEVELLING	84056913	2	1000265	4014486464207
14	DRUM DRIVE WITH REDUCTOR	84061615	1	1001884	4014486489408
15	HEADER, DRIVE 3HB	84061279	1	1001880	4014486489309
16	DRIVE, ROTARY SCREEN AND FAN	84057085	1	1000175	4014486462036
17	ROTOR AND VENTILATOR DRIVE	89835816	1	1002588	4014486495812
18	DRIVE, ROTARY SCREEN AND FAN	84061465	1	1002586	4014486495775
19	DRIVE : ALTERNATOR, WATERPUMP AND AIR	84057710	1	1002690	4014486482959
20	GRAIN ELEVATOR, DRIVE	84073457	1	1000256	4014486464054
21	ROTARY SEPARATOR DRIVE AND SHAFT	84457079	1	1001583	4014486484908
24	TAILING S ELEVATORS, BOTTOM AUGER AND (RH)	84058339	2	1000200	4014486462388
25	FAN VARIDRIVE FOR FIXED SHOE ONLY	919739	1	1001136	4014486497205
25	FAN VARIDRIVE FOR SELF-LEVELLING ONLY	84817627	1	1001135	4014486497199
22-23	DRIVE STRAW ELEVATOR 4HB	84334995	1	1004196	4014486652567

CX 8080

1	BEATER DRIVE	84045256	1	1000638	4014486469950
3	UNIO ADING AUGER	84061293	1	1001634	4014486485820
4	MAIN DRIVE	84057914	1	1003844	4014486490893
5	CHOPPER DRIVE	84075345	1	1001636	4014486485844
6	CHOPPER DRIVE	87339998	1	1004042	4014486519464
7	INTERMEDIATE SHAFT FOR CLEANING DRIVE, WITH SLOPE COMPENSATION	84057392	1	1003337	4014486484847
8	SHAKER SHOE DRIVE, FIXED SHOE, WITH SLOPE COMPENSATION	84432785	1	1000680	4014486470543
9	STRAW WALKER DRIVE	84057482	1	1000400	4014486466638
10	SHAKER SHOE AND TAILING S ELEVATOR DRIVE, WITH SLOPE COMPENSATION	84057874	1	1000699	4014486470826
11	TAILING S ELEVATOR DRIVE, FIXED SHOE, WITH SLOPE COMPENSATION	84435035	1	1001644	4014486485967
12	DRUM VARIATOR	84035748	1	1001316	4014486497892
13	SHAKER SHOE DRIVE - SELF-LEVELLING	84056913	2	1000265	4014486464207
14	DRUM DRIVE WITH REDUCTOR	84061615	1	1001884	4014486489408
15	HEADER, DRIVE 3HB	84061279	1	1001880	4014486489309
16	DRIVE, ROTARY SCREEN AND FAN	84057085	1	1000175	4014486462036
17	ROTOR AND VENTILATOR DRIVE	89835816	1	1002588	4014486495812
18	DRIVE, ROTARY SCREEN AND FAN	84061465	1	1002586	4014486495775
19	DRIVE : ALTERNATOR, WATERPUMP AND AIR	84057710	1	1002690	4014486482959
20	GRAIN ELEVATOR, DRIVE	84073457	1	1000256	4014486464054
21	ROTARY SEPARATOR DRIVE AND SHAFT	84457079	1	1001583	4014486484908
24	TAILING S ELEVATORS, BOTTOM AUGER AND (RH)	84058339	2	1000200	4014486462388
25	FAN VARIDRIVE FOR FIXED SHOE ONLY	919739	1	1001136	4014486497205
25	FAN VARIDRIVE FOR SELF-LEVELLING ONLY	84817627	1	1001135	4014486497199
22-23	DRIVE STRAW ELEVATOR 4HB	84334995	1	1004196	4014486652567

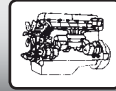

NEW HOLLAND

CX 8090

1	BEATER DRIVE	84045256	1	1000638	4014486469950
3	UNLOADING AUGER	84061293	1	1001634	4014486485820
4	MAIN DRIVE	84057914	1	1003844	4014486490893
5	CHOPPER DRIVE	84075345	1	1001636	4014486485844
6	CHOPPER DRIVE	87339998	1	1004042	4014486519464
7	INTERMEDIATE SHAFT FOR CLEANING DRIVE, WITH SLOPE COMPENSATION	84057392	1	1003337	4014486484847
8	SHAKER SHOE DRIVE, FIXED SHOE, WITH SLOPE COMPENSATION	84432785	1	1000680	4014486470543
9	STRAW WALKER DRIVE	84057482	1	1000400	4014486466638
10	SHAKER SHOE AND TAILINGS ELEVATOR DRIVE, WITH SLOPE COMPENSATION	84057874	1	1000699	4014486470826
11	TAILINGS ELEVATOR DRIVE, FIXED SHOE, WITH SLOPE COMPENSATION	84435035	1	1001644	4014486485967
12	DRUM VARIATOR FOR CX8030, CX8040, CX8050, CX8060, CX8070, CX8080 ONLY	84035748	1	1001316	4014486497892
13	SHAKER SHOE DRIVE - SELF-LEVELLING	84056913	2	1000265	4014486464207
14	DRUM DRIVE WITH REDUCTOR	84061615	1	1001884	4014486489408
15	HEADER, DRIVE 3HB	84061279	1	1001880	4014486489309
16	DRIVE, ROTARY SCREEN AND FAN	84057085	1	1000175	4014486462036
17	DRIVE, ROTARY SCREEN AND FAN	84459056	2	1004161	4014486523393
17	ROTOR AND VENTILATOR DRIVE	89835816	1	1002588	4014486495812
18	DRIVE, ROTARY SCREEN AND FAN	84061465	1	1002586	4014486495775
19	DRIVE: ALTERNATOR, WATERPUMP AND AIR	84057710	1	1002690	4014486482959
20	GRAIN ELEVATOR, DRIVE	84073457	1	1000256	4014486464054
21	ROTARY SEPARATOR DRIVE AND SHAFT	84457079	1	1001583	4014486484908
24	TAILINGS ELEVATORS, BOTTOM AUGER AND (RH)	84058339	2	1000200	4014486462388
25	FAN VARI-DRIVE FOR FIXED SHOE ONLY	919739	1	1001136	4014486497205
25	FAN VARI-DRIVE FOR SELF-LEVELLING ONLY	84817627	1	1001135	4014486497199
22-23	DRIVE STRAW ELEVATOR 4HB	84334995	1	1004196	4014486652567

CX 820

1	BEATER DRIVE	84045256	1	1000638	4014486469950
3	UNLOADING AUGER	84061293	1	1001634	4014486485820
4	MAIN DRIVE	84057914	1	1003844	4014486490893
5	CHOPPER DRIVE	84075345	1	1001636	4014486485844
6	CHOPPER DRIVE	84075635	1	1001687	4014486486612
7	INTERMEDIATE SHAFT FOR CLEANING DRIVE, WITH SLOPE COMPENSATION	84057392	1	1003337	4014486484847
8	SHAKER SHOE DRIVE, FIXED SHOE, WITH SLOPE COMPENSATION	84432785	1	1000680	4014486470543
9	STRAW WALKER DRIVE	84057482	1	1000400	4014486466638
10	SHAKER SHOE AND TAILINGS ELEVATOR DRIVE, WITH SLOPE COMPENSATION	84057874	1	1000699	4014486470826
11	TAILINGS ELEVATOR DRIVE, FIXED SHOE, WITH SLOPE COMPENSATION	84435035	1	1001644	4014486485967
12	DRUM VARIATOR	84035748	1	1001316	4014486497892
13	SHAKER SHOE DRIVE - SELF-LEVELLING	84056913	2	1000265	4014486464207
14	DRUM DRIVE	84061615	1	1001884	4014486489408
15	HEADER, DRIVE 3HB	84061279	1	1001880	4014486489309
16	DRIVE, ROTARY SCREEN AND FAN	84057085	1	1000175	4014486462036
17	ROTOR AND VENTILATOR DRIVE	89835816	1	1002588	4014486495812
18	BLOW-OFF SYSTEM, AIR COMPRESSOR	84061465	1	1002586	4014486495775
19	DRIVE: ALTERNATOR, WATERPUMP AND AIR	84057710	1	1002690	4014486482959
20	GRAIN ELEVATOR, DRIVE	84073457	1	1000256	4014486464054
21	ROTARY SEPARATOR DRIVE AND SHAFT, -> C415	84057393	1	1001581	4014486484885
21	ROTARY SEPARATOR DRIVE AND SHAFT, D416 ->	84457079	1	1001583	4014486484908
24	TAILINGS ELEVATORS, BOTTOM AUGER AND (RH)DRIVE	84058339	2	1000200	4014486462388
25	FAN VARI-DRIVE FOR FIXED SHOE ONLY	919739	1	1001136	4014486497205
25	FAN VARI-DRIVE FOR SELF-LEVELLING ONLY	84817627	1	1001135	4014486497199
22-23	DRIVE STRAW ELEVATOR 4HB	84334995	1	1004196	4014486652567

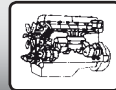

NEW HOLLAND

CX 840					
2	GRASS SEED EQUIPMENT - ACCESSORIES FOR SELF LEVELLING ONLY	84023277	1	1001132	4014486497168
2	GRASS SEED EQUIPMENT - ACCESSORIES FOR FIXED SHO E ONLY	84023278	1	1001133	4014486497175
3	SHAKER SHO E DRIVE - SELF-LEVELLING	84056913	2	1000265	4014486464207
4	INTERMEDIATE SHAFT - CLEANING DRIVE	84057392	1	1003337	4014486484847
5	STRAW WAIKER DRIVE	84057482	1	1000400	4014486466638
6	SHAKER SHO E AND TAILING S ELEVATOR DRIVE - SELF LEVELLING	84057874	1	1000699	4014486470826
7	TAILING S ELEVATORS - BOTTOM AUGER AND (RIGHT HAND) DRIVE	84058339	2	1000200	4014486462388
8	SHAKER SHO E DRIVE - FIXED SHO E	84432785	1	1000680	4014486470543
9	TAILING S ELEVATOR DRIVE - FIXED SHO E	84435035	1	1001644	4014486485967
10	MAIN FAN VARIABLE SPEED DRIVE FOR FIXED SHO E ONLY	919739	1	1001136	4014486497205
10	MAIN FAN VARIABLE SPEED DRIVE FOR SELF LEVELLING ONLY	9502654	1	1001135	4014486497199
11	ROTARY SCREEN AND FAN	84057085	1	1000175	4014486462036
12	ALTERNATOR, WATERPUMP AND AIR COMPRESSOR	84057710	1	1002690	4014486482959
13	MAIN DRIVE	84057914	1	1003844	4014486490893
14	ROTARY SCREEN AND FAN	84061465	1	1002586	4014486495775
15	AIR COMPRESSOR - BLOW-OFF SYSTEM	84061465	1	1002586	4014486495775
17	ROTARY SCREEN AND FAN	9835816	1	1002588	4014486495812
18	HEADER DRIVE	84061279	1	1001880	4014486489309
19	STRAW ELEVATOR DRIVE	84334995	1	1004196	4014486652567
20	STRAW ELEVATOR DRIVE	84434260	1	1001714	4014486486940
21	STRAW ELEVATOR DRIVE	84434295	1	1001645	4014486485974
22	DRUM DRIVE VARIABLE SPEED	84035748	1	1001316	4014486497892
23	BEATER DRIVE	84045256	1	1000638	4014486469950
24	ROTARY SEPARATOR DRIVE AND SHAFT	84057393	1	1001581	4014486484885
25	DRUM DRIVE WITH REDUCTOR	84061615	1	1001884	4014486489408
26	DRUM DRIVE WITH HOOT REDUCTOR	84061615	1	1001884	4014486489408
27	ROTARY SEPARATOR DRIVE AND SHAFT	84457079	1	1001583	4014486484908
28	UNLOADING AUGER DRIVE	84061293	1	1001634	4014486485820
29	ELEVATOR DRIVE GRAIN	84073457	1	1000256	4014486464054
1A	CHOPPER DRIVE	84075345	1	1001636	4014486485844
1B	CHOPPER DRIVE	84075635	1	1001687	4014486486612

CX 860					
2	GRASS SEED EQUIPMENT - ACCESSORIES FOR SELF LEVELLING ONLY	84023277	1	1001132	4014486497168
2	GRASS SEED EQUIPMENT - ACCESSORIES FOR FIXED SHO E ONLY	84023278	1	1001133	4014486497175
3	SHAKER SHO E DRIVE - SELF-LEVELLING	84056913	2	1000265	4014486464207
4	INTERMEDIATE SHAFT - CLEANING DRIVE	84057392	1	1003337	4014486484847
5	STRAW WAIKER DRIVE	84057482	1	1000400	4014486466638
6	SHAKER SHO E AND TAILING S ELEVATOR DRIVE - SELF LEVELLING	84057874	1	1000699	4014486470826
7	TAILING S ELEVATORS - BOTTOM AUGER AND (RIGHT HAND) DRIVE	84058339	2	1000200	4014486462388
8	SHAKER SHO E DRIVE - FIXED SHO E	84432785	1	1000680	4014486470543
9	TAILING S ELEVATOR DRIVE - FIXED SHO E	84435035	1	1001644	4014486485967
10	MAIN FAN VARIABLE SPEED DRIVE FOR FIXED SHO E ONLY	919739	1	1001136	4014486497205
10	MAIN FAN VARIABLE SPEED DRIVE FOR SELF LEVELLING ONLY	9502654	1	1001135	4014486497199
11	ROTARY SCREEN AND FAN	84057085	1	1000175	4014486462036
12	ALTERNATOR, WATERPUMP AND AIR COMPRESSOR	84057710	1	1002690	4014486482959
13	MAIN DRIVE	84057914	1	1003844	4014486490893
14	ROTARY SCREEN AND FAN	84061465	1	1002586	4014486495775
15	AIR COMPRESSOR - BLOW-OFF SYSTEM	84061465	1	1002586	4014486495775
18	HEADER DRIVE	84061279	1	1001880	4014486489309
19	STRAW ELEVATOR DRIVE	84334995	1	1004196	4014486652567
20	STRAW ELEVATOR DRIVE	84434260	1	1001714	4014486486940
21	STRAW ELEVATOR DRIVE	84434295	1	1001645	4014486485974

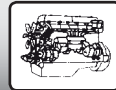

NEW HOLLAND

22	DRUM DRIVE VARIABLE SPEED	84035748	1	1001316	4014486497892
23	BEATER DRIVE	84045256	1	1000638	4014486469950
24	RO'TARY SEPARATO R DRIVE AND SHAFT	84057393	1	1001581	4014486484885
25	DRUM DRIVE W ITH REDUCTO R	84061615	1	1001884	4014486489408
26	DRUM DRIVE W ITHO UT REDUCTO R	84061615	1	1001884	4014486489408
27	RO'TARY SEPARATO R DRIVE AND SHAFT	84457079	1	1001583	4014486484908
28	UNIO ADING AUGER DRIVE	84061293	1	1001634	4014486485820
29	ELEVATO R DRIVE G RAIN	84073457	1	1000256	4014486464054
1A	CHO PPER DRIVE	84075345	1	1001636	4014486485844
1B	CHO PPER DRIVE	84075635	1	1001687	4014486486612

CX 880

2	GRASS SEED EQ UIPMENT - ACCESSO RIES FO R SELF LEVELLING O NLY	84023277	1	1001132	4014486497168
2	GRASS SEED EQ UIPMENT - ACCESSO RIES FO R FIXED SHO E O NLY	84023278	1	1001133	4014486497175
3	SHAKER SHO E DRIVE - SELF-LEVELLING	84056913	2	1000265	4014486464207
4	INTERMEDIATE SHAFT - CLEANING DRIVE	84057392	1	1003337	4014486484847
5	STRAW WAIKER DRIVE	84057482	1	1000400	4014486466638
6	SHAKER SHO E AND TAILIN GS ELEVATO R DRIVE - SELF LEVELLING	84057874	1	1000699	4014486470826
7	TAILIN GS ELEVATO RS - BO TTOM AUGER AND (RIG HT HAND) DRIVE	84058339	2	1000200	4014486462388
8	SHAKER SHO E DRIVE - FIXED SHO E	84432785	1	1000680	4014486470543
9	TAILIN GS ELEVATO R DRIVE - FIXED SHO E	84435035	1	1001644	4014486485967
10	MAIN FAN VARIABLE SPEED DRIVE FO R FIXED SHO E O NLY	919739	1	1001136	4014486497205
10	MAIN FAN VARIABLE SPEED DRIVE FO R SELF LEVELLING O NLY	9502654	1	1001135	4014486497199
11	RO'TARY SCREEN AND FAN	84057085	1	1000175	4014486462036
12	ALTERNATO R, WATERPUMP AND AIR CO MPRESSO R	84057710	1	1002690	4014486482959
13	MAIN DRIVE	84057914	1	1003844	4014486490893
14	RO'TARY SCREEN AND FAN	84061465	1	1002586	4014486495775
15	AIR CO MPRESSO R - BIO W -O FF SYSTEM	84061465	1	1002586	4014486495775
18	HEADER DRIVE	84061279	1	1001880	4014486489309
19	STRAW ELEVATO R DRIVE	84334995	1	1004196	4014486652567
20	STRAW ELEVATO R DRIVE	84434260	1	1001714	4014486486940
21	STRAW ELEVATO R DRIVE	84434295	1	1001645	4014486485974
22	DRUM DRIVE VARIABLE SPEED	84035748	1	1001316	4014486497892
23	BEATER DRIVE	84045256	1	1000638	4014486469950
24	RO'TARY SEPARATO R DRIVE AND SHAFT	84057393	1	1001581	4014486484885
25	DRUM DRIVE W ITH REDUCTO R	84061615	1	1001884	4014486489408
26	DRUM DRIVE W ITHO UT REDUCTO R	84061615	1	1001884	4014486489408
27	RO'TARY SEPARATO R DRIVE AND SHAFT	84457079	1	1001583	4014486484908
28	UNIO ADING AUGER DRIVE	84061293	1	1001634	4014486485820
29	ELEVATO R DRIVE G RAIN	84073457	1	1000256	4014486464054
1A	CHO PPER DRIVE	84075345	1	1001636	4014486485844
1B	CHO PPER DRIVE	84075635	1	1001687	4014486486612

FX 300

1	MAIN DRIVE	84017742	2	1001167	4014486491784
2	DRIVE	84026761	4	1002746	4014486461862
3	FAN DRIVE	84012975	2	1002087	4014486519129
4	ALTERNATO R DRIVE	84022807	1	1001132	4014486497168
5	CO MPRESSO R DRIVE	80747177	1	1002582	4014486495638
5	CO MPRESSO R DRIVE	89835815	1	1002588	4014486495812

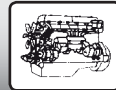
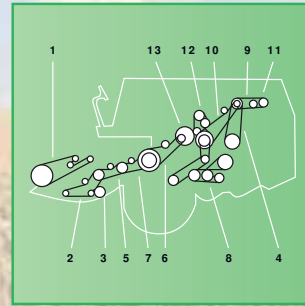
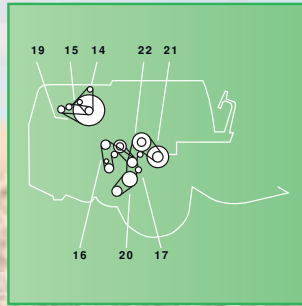
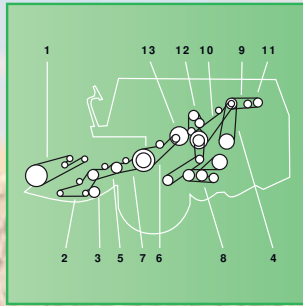
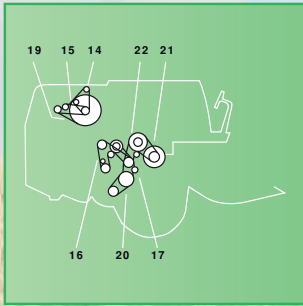

NEW HOLLAND

FX 375

1	MAIN DRIVE	84017742	2	1001167	4014486491784
2	DRIVE	84026761	4	1002746	4014486461862
3	FAN DRIVE	84012975	2	1002087	4014486519129
4	ALTERNATOR DRIVE	84022807	1	1001132	4014486497168
5	COMPRESSOR DRIVE	80747177	1	1002582	4014486495638
5	COMPRESSOR DRIVE	89835815	1	1002588	4014486495812

FX 450

1	MAIN DRIVE	84017742	2	1001167	4014486491784
2	DRIVE	84026761	4	1002746	4014486461862
3	FAN DRIVE	84012975	2	1002087	4014486519129
4	ALTERNATOR DRIVE	84022807	1	1001132	4014486497168
5	COMPRESSOR DRIVE	80747177	1	1002582	4014486495638
5	COMPRESSOR DRIVE	89835815	1	1002588	4014486495812

M 103

1	THRESHING DRUM VARIATOR DRIVE	80230078	1	1001509	4014486460254
8	REEL DRIVE IN INTERMEDIATE SHAFT - (LOWER)	80230057	1	1000603	4014486469370
10	REEL DRIVE	80230060	1	1003534	4014486470536
11	HYDRAULIC PUMP DRIVE	80230043	1	1003400	4014486462906
18	POWER STEERING	80230043	1	1003400	4014486462906
26	AUGER DRIVE GRAIN TANK	80230045	1	1001568	4014486484717

M 122

1	HYDRAULIC PUMP DRIVE	80230043	1	1003400	4014486462906
2	TAILINGS ELEVATOR	80230046	1	1004468	4014486712124
3	STRAW ELEVATOR DRIVE	80230059	1	1000654	4014486470178
4	GRAIN TANK UNLOADING	80230061	1	1000717	4014486471076
5	REEL DRIVE	80230061	1	1000717	4014486471076
11	ELEVATOR DRIVE	80230046	1	1004468	4014486712124
12	CYLINDER	80230078	1	1001509	4014486460254
13	UNLOADING SYSTEM	80326298	1	1003489	4014486468427
14	FAN DRIVE	80330204	1	1000243	4014486463613
15	DEUTZ ENGINE	80327040	1	1002267	4014486478358

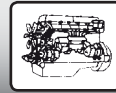
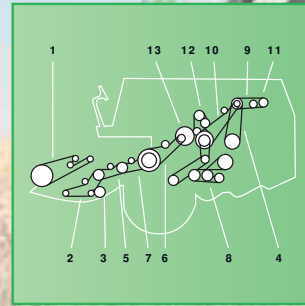
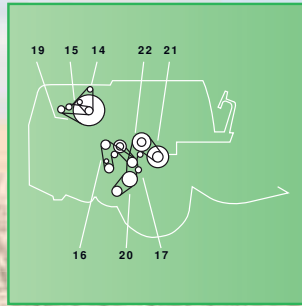
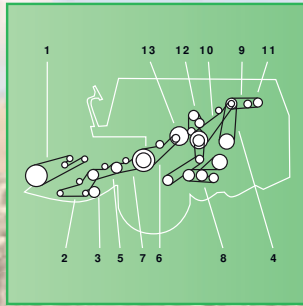
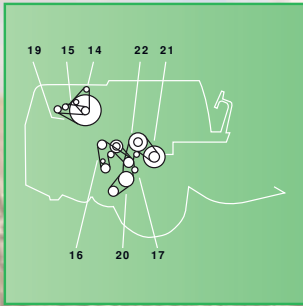

NEW HOLLAND

M 133

1	HYDRAULIC PUMP DRIVE	80230043	1	1003400	4014486462906
2	REEL DRIVE ECCENTRIC	80230060	1	1003534	4014486470536
3	REEL DRIVE	80230061	1	1000717	4014486471076
4	STRAW ELEVATOR DRIVE	80230073	1	1000904	4014486473506
11	FAN DRIVE VARIABLE SPEED	80230056	1	1003232	4014486518658
12	TAILINGS ELEVATOR DRIVE	80230057	1	1000603	4014486469370
12	ELEVATOR DRIVE GRAIN	80230059	1	1000654	4014486470178
13	ELEVATOR DRIVE UNIT	80230059	1	1000654	4014486470178
14	CYLINDER	80230078	1	1001509	4014486460254
16	DISCHARGE AUGER SHAFT	80230103	1	1000881	4014486473216
17	STRAW WALKER DRIVE	80230108	1	1003452	4014486465617
18	FAN DRIVE	80336386	1	1000027	4014486483482
19	ALTERNATOR DRIVE	80336426	1	1000020	4014486483390

M 135

1	HYDRAULIC PUMP DRIVE	80230043	1	1003400	4014486462906
2	REEL DRIVE ECCENTRIC	80230060	1	1003534	4014486470536
3	REEL DRIVE	80230061	1	1000717	4014486471076
4	STRAW ELEVATOR DRIVE	80230073	1	1000904	4014486473506
11	FAN DRIVE VARIABLE SPEED	80230056	1	1003232	4014486518658
12	TAILINGS ELEVATOR DRIVE	80230057	1	1000603	4014486469370
12	ELEVATOR DRIVE GRAIN	80230059	1	1000654	4014486470178
13	ELEVATOR DRIVE UNIT	80230059	1	1000654	4014486470178
14	CYLINDER	80230078	1	1001509	4014486460254
16	DISCHARGE AUGER SHAFT	80230103	1	1000881	4014486473216
17	STRAW WALKER DRIVE	80230108	1	1003452	4014486465617
18	FAN DRIVE	80336386	1	1000027	4014486483482
19	ALTERNATOR DRIVE	80336426	1	1000020	4014486483390

M 140

1	HYDRAULIC PUMP DRIVE	80230043	1	1003400	4014486462906
2	REEL DRIVE ECCENTRIC	80230060	1	1003534	4014486470536
3	REEL DRIVE	80230061	1	1000717	4014486471076
4	STRAW ELEVATOR DRIVE	80230073	1	1000904	4014486473506
11	FAN DRIVE VARIABLE SPEED	80230056	1	1003232	4014486518658
12	TAILINGS ELEVATOR DRIVE	80230057	1	1000603	4014486469370
12	ELEVATOR DRIVE GRAIN	80230059	1	1000654	4014486470178
13	ELEVATOR DRIVE UNIT	80230059	1	1000654	4014486470178
14	CYLINDER	80230078	1	1001509	4014486460254
16	DISCHARGE AUGER SHAFT	80230103	1	1000881	4014486473216
17	STRAW WALKER DRIVE	80230108	1	1003452	4014486465617
18	FAN DRIVE	80336386	1	1000027	4014486483482
19	ALTERNATOR DRIVE	80336426	1	1000020	4014486483390

M 80

1	HYDRAULIC PUMP DRIVE	80230043	1	1003400	4014486462906
2	TAILINGS ELEVATOR	80230046	1	1004468	4014486712124
5	STRAW ELEVATOR DRIVE	80230059	1	1000654	4014486470178
6	REEL DRIVE	80230060	1	1003534	4014486470536
7	STICKLE KNIFE DRIVE	80230060	1	1003534	4014486470536
8	GRAIN TANK UNLOADING	80230061	1	1000717	4014486471076
18	ELEVATOR DRIVE	80230046	1	1004468	4014486712124
20	CYLINDER	80230078	1	1001509	4014486460254

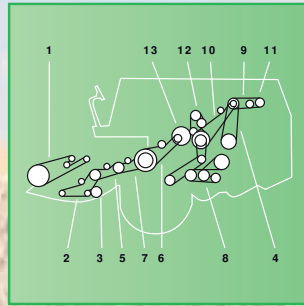
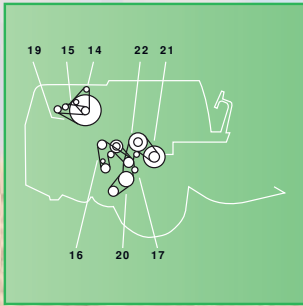

NEW HOLLAND

M 89

1	HYDRAULIC PUMP DRIVE	80230043	1	1003400	4014486462906
3	STRAW ELEVATOR DRIVE	80230059	1	1000654	4014486470178
4	REEL DRIVE	80230060	1	1003534	4014486470536
5	STICKLE KNIFE DRIVE	80230060	1	1003534	4014486470536
6	GRAIN TANK UNLOADING	80230061	1	1000717	4014486471076
10	TAILINGS ELEVATOR	80230046	1	1004468	4014486712124
14	ELEVATOR DRIVE	80230046	1	1004468	4014486712124
16	CYLINDER	80230078	1	1001509	4014486460254

TC 5040

3	DRIVE, ROTARY SCREEN AND FAN	84989965	1	1000169	4014486461954
4	AIR CONDITIONING FAN DRIVE	9818704	1	1000074	4014486483949
4	INTERMEDIATE SHAFT DRIVE	87535206	1	1003727	4014486495164
4	AIR CONDITIONING FAN DRIVE	89818704	1	1000074	4014486483949
7	UNLOADING AUGER DRIVE	84448591	1	1000657	4014486470215
8	HEADER DRIVE ENGAGING IDLER 3HB ONLY	89817374	1	1001876	4014486489231
9	UPPER GROUND SPEED	80356024	1	1001489	4014486459999
10	VARIATOR DRIVE	9850782	1	1001491	4014486460018
10	VARIATOR DRIVE	89850782	1	1001491	4014486460018
11	DRIVE GROUP FOR GRAIN AND TAILINGS ELEVATOR	80422731	1	1000696	4014486470772
12	ECCENTRIC SHAFT DRIVE	80387469	1	1000700	4014486470833
15	DRUM VARIDRIVE CONTROL	336784	1	1001506	4014486460216
16	FAN VARIDRIVE	9515075	1	1001428	4014486459364
16	FAN VARIDRIVE	89515075	1	1001428	4014486459364
17	FAN VARIDRIVE	9515076	1	1001416	4014486459234
17	FAN VARIDRIVE	89515076	1	1001416	4014486459234
18	STRAW WALKER SHAFT	80431784	1	1000328	4014486465587
20	ROTARY SEPARATOR DRIVE	89837412	1	1000573	4014486468816
13-14	2HC DRIVE BESIDE STRAW ELEVATOR	84971217	1	1001782	4014486520385

TC 5050

3	DRIVE, ROTARY SCREEN AND FAN	84989965	1	1000169	4014486461954
4	AIR CONDITIONING FAN DRIVE	9818704	1	1000074	4014486483949
4	INTERMEDIATE SHAFT DRIVE	87535206	1	1003727	4014486495164
4	AIR CONDITIONING FAN DRIVE	89818704	1	1000074	4014486483949
7	UNLOADING AUGER DRIVE	84448591	1	1000657	4014486470215
8	HEADER DRIVE ENGAGING IDLER 3HB ONLY	89817374	1	1001876	4014486489231
11	DRIVE GROUP FOR GRAIN AND TAILINGS ELEVATOR	80422731	1	1000696	4014486470772
12	ECCENTRIC SHAFT DRIVE	80387469	1	1000700	4014486470833
15	DRUM VARIDRIVE CONTROL	336784	1	1001506	4014486460216
16	FAN VARIDRIVE	9515075	1	1001428	4014486459364
16	FAN VARIDRIVE	89515075	1	1001428	4014486459364
17	FAN VARIDRIVE	9515076	1	1001416	4014486459234
17	FAN VARIDRIVE	89515076	1	1001416	4014486459234
18	STRAW WALKER SHAFT	80431784	1	1000328	4014486465587
19	SUSPENSION HYDROSTATIC PUMP	89818873	1	1003662	4014486490718
20	ROTARY SEPARATOR DRIVE	89837412	1	1000573	4014486468816
13-14	2HC DRIVE BESIDE STRAW ELEVATOR	84971217	1	1001782	4014486520385

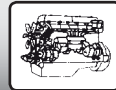

NEW HOLLAND

TC 5060

3	DRIVE, ROTARY SCREEN AND FAN	84989965	1	1000169	4014486461954
4	AIR CONDITIONING FAN DRIVE	9818704	1	1000074	4014486483949
4	INTERMEDIATE SHAFT DRIVE	87535206	1	1003727	4014486495164
4	AIR CONDITIONING FAN DRIVE	89818704	1	1000074	4014486483949
7	UNLOADING AUGER DRIVE	84448591	1	1000657	4014486470215
8	HEADER DRIVE ENGAGING IDLER 3HB ONLY	89817374	1	1001876	4014486489231
9	UPPER GROUND SPEED	80356024	1	1001489	4014486459999
10	VARIATOR DRIVE	9850782	1	1001491	4014486460018
10	VARIATOR DRIVE	89850782	1	1001491	4014486460018
11	DRIVE GROUP FOR GRAIN AND TAILINGS ELEVATOR	80422731	1	1000696	4014486470772
12	ECCENTRIC SHAFT DRIVE	80387469	1	1000700	4014486470833
15	DRUM VARIDRIVE CONTROL	336784	1	1001506	4014486460216
16	FAN VARIDRIVE	9515075	1	1001428	4014486459364
16	FAN VARIDRIVE	89515075	1	1001428	4014486459364
17	FAN VARIDRIVE	9515076	1	1001416	4014486459234
17	FAN VARIDRIVE	89515076	1	1001416	4014486459234
18	STRAW WALKER SHAFT	80431784	1	1000328	4014486465587
20	ROTARY SEPARATOR DRIVE	89837412	1	1000573	4014486468816
13-14	2HC DRIVE BESIDE STRAW ELEVATOR	84971217	1	1001782	4014486520385

TC 5070

3	DRIVE, ROTARY SCREEN AND FAN	84989965	1	1000169	4014486461954
4	AIR CONDITIONING FAN DRIVE	9818704	1	1000074	4014486483949
4	AIR CONDITIONING FAN DRIVE	89818704	1	1000074	4014486483949
7	UNLOADING AUGER DRIVE	84448591	1	1000657	4014486470215
8	HEADER DRIVE ENGAGING IDLER 3HB ONLY	89817374	1	1001876	4014486489231
11	DRIVE GROUP FOR GRAIN AND TAILINGS ELEVATOR	80422731	1	1000696	4014486470772
12	ECCENTRIC SHAFT DRIVE	80387469	1	1000700	4014486470833
15	DRUM VARIDRIVE CONTROL	336784	1	1001506	4014486460216
16	FAN VARIDRIVE	9515075	1	1001428	4014486459364
16	FAN VARIDRIVE	89515075	1	1001428	4014486459364
17	FAN VARIDRIVE	9515076	1	1001416	4014486459234
17	FAN VARIDRIVE	89515076	1	1001416	4014486459234
18	STRAW WALKER SHAFT	80431784	1	1000328	4014486465587
19	SUSPENSION HYDROSTATIC PUMP	89818873	1	1003662	4014486490718
20	ROTARY SEPARATOR DRIVE	89837412	1	1000573	4014486468816
13-14	2HC DRIVE BESIDE STRAW ELEVATOR	84971217	1	1001782	4014486520385

TC 5080

3	DRIVE, ROTARY SCREEN AND FAN	84989965	1	1000169	4014486461954
4	AIR CONDITIONING FAN DRIVE	9818704	1	1000074	4014486483949
4	AIR CONDITIONING FAN DRIVE	89818704	1	1000074	4014486483949
7	UNLOADING AUGER DRIVE	84448591	1	1000657	4014486470215
8	HEADER DRIVE ENGAGING IDLER 3HB ONLY	89817374	1	1001876	4014486489231
11	DRIVE GROUP FOR GRAIN AND TAILINGS ELEVATOR	80422731	1	1000696	4014486470772
12	ECCENTRIC SHAFT DRIVE	80387469	1	1000700	4014486470833
15	DRUM VARIDRIVE CONTROL	336784	1	1001506	4014486460216
16	FAN VARIDRIVE	9515075	1	1001428	4014486459364
16	FAN VARIDRIVE	89515075	1	1001428	4014486459364
17	FAN VARIDRIVE	9515076	1	1001416	4014486459234
17	FAN VARIDRIVE	89515076	1	1001416	4014486459234
18	STRAW WALKER SHAFT	80431784	1	1000328	4014486465587
19	SUSPENSION HYDROSTATIC PUMP	89818873	1	1003662	4014486490718

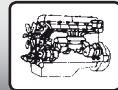
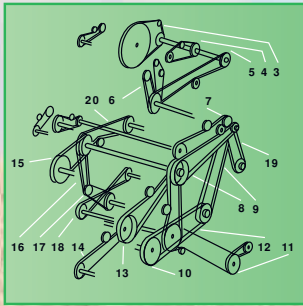

NEW HOLLAND

20	RO TARY SEPARATO R DRIVE	89837412	1	1000573	4014486468816
13-14	2HC DRIVE BESIDE STRAW ELEVATO R	84971217	1	1001782	4014486520385

TC 52

3	RO TARY DUST SCREEN DRIVE	89514310	1	1000152	4014486461725
4	RADIATO R FAN (FO R TC52 O NLY)	89831515	1	No AP	
5	ENG IN E	89818705	1	1000079	4014486484007
6	ALTERNATO R AND WATERPUMP DRIVE (W ITHO UT AIR CO MPRESSO R)	84005860	1	1002636	4014486480405
7	IN TERMEDIATE SHAFT - ENG IN E	9838606	1	1000654	4014486470178
7	IN TERMEDIATE SHAFT - ENG IN E	89838606	1	1000654	4014486470178
8	BEATER SHAFT - MAIN DRIVE	89817374	1	1001876	4014486489231
11	AUGER (G RAIN)	80422731	1	1000696	4014486470772
12	BEATER SHAFT - ECCEN TRIC SHAFT	80387469	1	1000700	4014486470833
13	STRAW ELEVATO R - BEATER SHAFT	80066232	1	1000690	4014486470697
13	STRAW ELEVATO R - BEATER SHAFT	80424563	1	1001765	4014486487480
14	HEADER DRIVE (CO DE 0212) TC 52-54	89817487	1	1004471	4014486712131
14	HEADER DRIVE (CO DE 0212) TC 52-54	89817488	1	1001780	4014486487671
14	HEADER DRIVE (CO DE 1300) FO R L CON V. TC52-54	89835120	1	1001781	4014486487688
14	HEADER DRIVE (CO DE 1300) FO R L CON V. TC52-54	89839375	1	1000774	4014486471830
15	DRUM - BEATER SHAFT	80336784	1	1001506	4014486460216
16	BEATER SHAFT	89515075	1	1001428	4014486459364
17	FAN DRIVE	89515076	1	1001416	4014486459234
18	STRAW WAIKER - ECCEN TRIC SHAFT	80431784	1	1000328	4014486465587
19	HYDRO STATIC PUMP (CO DE 0800)	89818873	1	1003662	4014486490718
20	RO TARY SEPARATO R (CO DE 2300)	89837412	1	1000573	4014486468816

TC 54

3	RO TARY DUST SCREEN DRIVE	89514310	1	1000152	4014486461725
4	RADIATO R FAN (FO R TC54-56 O NLY)	89818704	1	1000074	4014486483949
5	ENG IN E	89818705	1	1000079	4014486484007
6	ALTERNATO R AND WATERPUMP DRIVE (W ITHO UT AIR CO MPRESSO R)	84005860	1	1002636	4014486480405
7	IN TERMEDIATE SHAFT - ENG IN E	9838606	1	1000654	4014486470178
8	BEATER SHAFT - MAIN DRIVE	89817374	1	1001876	4014486489231
11	AUGER (G RAIN)	80422731	1	1000696	4014486470772
12	BEATER SHAFT - ECCEN TRIC SHAFT	80387469	1	1000700	4014486470833
13	STRAW ELEVATO R - BEATER SHAFT	80066232	1	1000690	4014486470697
13	STRAW ELEVATO R - BEATER SHAFT	80424563	1	1001765	4014486487480
14	HEADER DRIVE (CO DE 0212) TC 52-54	89817487	1	1004471	4014486712131
14	HEADER DRIVE (CO DE 0212) TC 52-54	89817488	1	1001780	4014486487671
14	HEADER DRIVE (CO DE 1300) FO R L CON V. TC52-54	89835120	1	1001781	4014486487688
14	HEADER DRIVE (CO DE 1300) FO R L CON V. TC52-54	89839375	1	1000774	4014486471830
15	DRUM - BEATER SHAFT	80336784	1	1001506	4014486460216
16	BEATER SHAFT	89515075	1	1001428	4014486459364
17	FAN DRIVE	89515076	1	1001416	4014486459234
18	STRAW WAIKER - ECCEN TRIC SHAFT	80431784	1	1000328	4014486465587
19	HYDRO STATIC PUMP (CO DE 0800)	89818873	1	1003662	4014486490718
20	RO TARY SEPARATO R (CO DE 2300)	89837412	1	1000573	4014486468816

TC 56

3	RO TARY DUST SCREEN DRIVE	89514310	1	1000152	4014486461725
4	RADIATO R FAN (FO R TC54-56 O NLY)	89818704	1	1000074	4014486483949
5	ENG IN E	89818705	1	1000079	4014486484007
6	ALTERNATO R AND WATERPUMP DRIVE (W ITHO UT AIR CO MPRESSO R)	84005860	1	1002636	4014486480405
7	IN TERMEDIATE SHAFT - ENG IN E	9838606	1	1000654	4014486470178
8	BEATER SHAFT - MAIN DRIVE	89817374	1	1001876	4014486489231

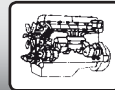
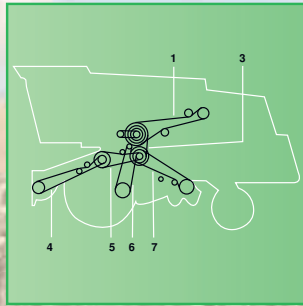
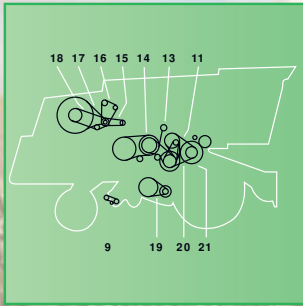

NEW HOLLAND

11	AUGER (GRAIN)	80422731	1	1000696	4014486470772
12	BEATER SHAFT - ECCENTRIC SHAFT	80387469	1	1000700	4014486470833
13	STRAW ELEVATOR - BEATER SHAFT	80066232	1	1000690	4014486470697
13	STRAW ELEVATOR - BEATER SHAFT	80424563	1	1001765	4014486487480
14	HEADER DRIVE (CODE 0209) TC56	89817487	1	1004471	4014486712131
14	HEADER DRIVE (CODE 0209) TC56	89817488	1	1001780	4014486487671
14	HEADER DRIVE (CODE 1000) FOR L CONV. TC56	89835120	1	1001781	4014486487688
14	HEADER DRIVE (CODE 1000) FOR L CONV. TC56	89839375	1	1000774	4014486471830
15	DRUM - BEATER SHAFT	80336784	1	1001506	4014486460216
16	BEATER SHAFT	89515075	1	1001428	4014486459364
17	FAN DRIVE	89515076	1	1001416	4014486459234
18	STRAW WAIKER - ECCENTRIC SHAFT	80431784	1	1000328	4014486465587
19	HYDROSTATIC PUMP (CODE 0800)	89818873	1	1003662	4014486490718
20	ROTARY SEPARATOR (CODE 2300)	89837412	1	1000573	4014486468816

TC 57

1		89838606	1	1000654	4014486470178
4	STRAW ELEVATOR - BEATER SHAFT	80424563	1	1001765	4014486487480
5		80825013	1	1001562	4014486484632
7		80330715	1	1000726	4014486471182
9		80755808	1	1001488	4014486459975
15	BEATER SHAFT	89515075	1	1001428	4014486459364
16	FAN DRIVE	89515076	1	1001416	4014486459234
17		80387460	1	1001537	4014486460568
18	STRAW WAIKER - ECCENTRIC SHAFT	80431784	1	1000328	4014486465587

TF 42

3	BEATER TO INTERMEDIATE SHAFT (MERCEDES ENGINE)	80455865	1	1001954	4014486490596
4	STRAW ELEVATOR DRIVE	80433746	2	1000405	4014486466683
5	BEATER TO STRAW ELEVATOR	80350236	1	1003640	4014486489002
5	BEATER TO STRAW ELEVATOR	80434222	1	1001635	4014486485837
5	BEATER TO STRAW ELEVATOR	80743877	1	1003349	4014486490985
6	GROUND SPEED VARIATOR DRIVE	80440780	1	No AP	
7	SHAKER SHOE DRIVE	80448794	1	1000756	4014486471571
11	BEATER (REAR) TO DRUM SHAFT	80186347	1	1003809	4014486518740
13	INTERMEDIATE SHAFT - ROTARY SEPARATOR	80434047	1	1001602	4014486485240
14	ROTARY SEPARATOR TO ROTOR	80434046	1	1000657	4014486470215
16	MERCEDES ENGINE	80432642	1	1003746	4014486495928
17	DUST CAP	80439495	1	1000173	4014486462005
18	FAN DRIVE	80439496	1	1002609	4014486496161
19	FAN DRIVE	80439832	1	1001415	4014486459227
20	DRUM SHAFT TO INTERMEDIATE SHAFT	80434160	1	No AP	
21	INTERMEDIATE SHAFT - GRAIN ELEVATOR	80433639	1	1000237	4014486463408

TF 44

3	BEATER TO INTERMEDIATE SHAFT (MERCEDES ENGINE)	80455865	1	1001954	4014486490596
4	STRAW ELEVATOR DRIVE	80433746	2	1000405	4014486466683
5	BEATER TO STRAW ELEVATOR	80350236	1	1003640	4014486489002
5	BEATER TO STRAW ELEVATOR	80434222	1	1001635	4014486485837
5	BEATER TO STRAW ELEVATOR	80743877	1	1003349	4014486490985
6	GROUND SPEED VARIATOR DRIVE	80440780	1	No AP	
7	SHAKER SHOE DRIVE	80448794	1	1000756	4014486471571
11	BEATER (REAR) TO DRUM SHAFT	80186347	1	1003809	4014486518740
13	INTERMEDIATE SHAFT - ROTARY SEPARATOR	80434047	1	1001602	4014486485240
14	ROTARY SEPARATOR TO ROTOR	80434046	1	1000657	4014486470215

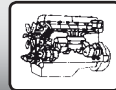

NEW HOLLAND

16	MERCEDES ENGINE	80432642	1	1003746	4014486495928
17	DUST CAP	80439495	1	1000173	4014486462005
18	FAN DRIVE	80439496	1	1002609	4014486496161
19	FAN DRIVE	80439832	1	1001415	4014486459227
20	DRUM SHAFT TO INTERMEDIATE SHAFT	80434160	1	No AP	
21	INTERMEDIATE SHAFT - GRAIN ELEVATOR	80433639	1	1000237	4014486463408

TF 46

1	BEATER TO INTERMEDIATE DRIVE	80750166	1	1001242	4014486491975
2	MAIN DRIVE 4HB	750290	1	1002008	4014486491371
2	MAIN DRIVE 4HB	80750290	1	1002008	4014486491371
3	DRUM DRIVE	84817628	1	1003345	4014486469844
4	STRAW ELEVATOR DRIVE - WITH LATERAL FLOW TATION, 7401001 - 7406999	80453268	2	1000319	4014486465389
4	COUNTERSHAFT	80919681	1	1001602	4014486485240
5	GRAIN ELEVATOR DRUM DRIVE 3HB	84817632	1	1003639	4014486488999
5	GRAIN TANK UNLOADING	84817636	1	1003404	4014486463255
6	CLEANING SHOE DRIVE	448794	1	1000756	4014486471571
6	INTERMEDIATE SHAFT DRIVE	89832601	1	1001288	4014486497861
7	ROTARY SEPARATOR	84448591	1	1000657	4014486470215
8	ROTOR TO UNDERSHOT BEATER	80427456	1	1003351	4014486464603
9	FAN DRIVE	80750318	1	1001134	4014486497182
9	ROTARY DUST SCREEN DRIVE, 7404001 - 7409999	87374615	1	1004049	4014486518436
10	COOLING FAN DRIVE - INTERMEDIATE SHAFT	80439496	1	1002609	4014486496161
11	WATERPUMP AND ALTERNATOR DRIVE, 7416001 - 7418999	452023	2	1002976	4014486495997
11	WATERPUMP AND ALTERNATOR DRIVE, 7401001 - 7415999	80748003	2	1002974	4014486495935
12	DUST - SCREEN BELT	80436304	1	1002482	4014486493788
14	MAIN DRIVE 2HB	84000191	1	1003616	4014486486667
16	CHOPPER DRIVE, 7422001 -	84000189	1	1000666	4014486470338
17	CHOPPER DRIVE, 7410001 -	80457309	1	1000181	4014486462104
18	WATERPUMP DRIVE	80443634	1	1002543	4014486494723

TF 76

1	MAIN DRIVE BELT	84817623	1	1001954	4014486490596
2	HYDROSTATIC DRIVE	84817631	1	1002006	4014486491340
3	FAN DRIVE	84817629	1	1001557	4014486484564
4	DRIVE BESIDES STRAW ELEVATOR 4HB	9593400	1	1002029	4014486491647
4	GRAIN ELEVATOR DRIVE	89593418	1	No AP	
5	BEATER TO STRAW ELEVATOR 2HB	80434222	1	1001635	4014486485837
5	BEATER TO STRAW ELEVATOR 2HB	84817632	1	1003639	4014486488999
6	SHAKER SHOE DRIVE	448794	1	1000756	4014486471571
10	CHOPPER, DRIVE FOR TF76 ONLY	84000189	1	1000666	4014486470338
12	DRUM DRIVE	84817628	1	1003345	4014486469844
13	EXTENSION COUNTERSHAFT	80919681	1	1001602	4014486485240
14	AUGER DRIVE	84817636	1	1003404	4014486463255
15	BEATER TO INTERMEDIATE DRIVE	89832601	1	1001288	4014486497861
16	ROTARY SEPARATOR	84448591	1	1000657	4014486470215
17	THROW-OUT BEATER DRIVE	80427456	1	1003351	4014486464603
18	CLEANING FAN DRIVE	84817627	1	1001135	4014486497199
21		84000189	1	1000666	4014486470338
22	CENTRIFUGAL SEPARATOR	84817639	1	1002608	4014486496154
23	ALTERNATOR, WATERPUMP AND FAN	84817638	1	1003807	4014486483048
24	HYDRAULIC PUMP	84817670	2	1002969	4014486495584
25	CLEANING FAN DRIVE	84817630	1	1002606	4014486496130
26	COMPRESSOR DRIVE	84817626	1	1002579	4014486495560
27	ROTARY SIEVE	84022715	1	No AP	

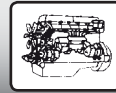
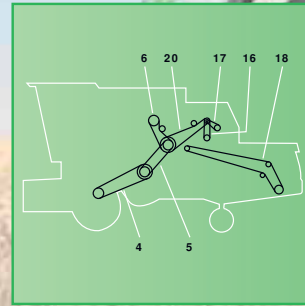
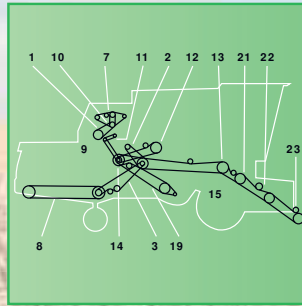
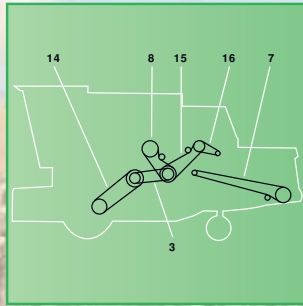
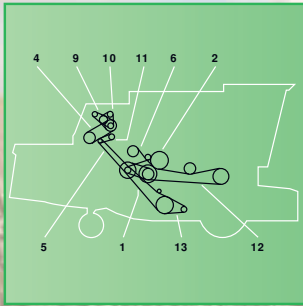

NEW HOLLAND

TF 78

1	THRESHING, DRIVE, BELT AND GUARD	80750166	1	1001242	4014486491975
2	HYDROSTATIC DRIVE	84817631	1	1002006	4014486491340
3	FAN DRIVE 2 HB	84817629	1	1001557	4014486484564
4	DRIVE BESIDES STRAW ELEVATOR 4HB	9593400	1	1002029	4014486491647
4	GRAIN ELEVATOR DRIVE	89593418	1	No AP	
5	BEATER TO STRAW ELEVATOR 2HB	80434222	1	1001635	4014486485837
5	BEATER TO STRAW ELEVATOR 2HB	84817632	1	1003639	4014486488999
6	SHAKER SHOE DRIVE	448794	1	1000756	4014486471571
10	CHOPPER, DRIVE FOR TF78 ONLY	84000189	1	1000666	4014486470338
12	DRUM DRIVE	84817628	1	1003345	4014486469844
13	EXTENSION COUNTERSHAFT	80919681	1	1001602	4014486485240
14	AUGER DRIVE	84817636	1	1003404	4014486463255
15	BEATER TO INTERMEDIATE DRIVE	89832601	1	1001288	4014486497861
16	ROTARY SEPARATOR	84448591	1	1000657	4014486470215
17	THROW-OUT BEATER DRIVE	80427456	1	1003351	4014486464603
18	CLEANING FAN DRIVE	84817627	1	1001135	4014486497199
22	ROTARY SCREEN DRIVE	84021588	1	1000083	4014486519358
23	AIR CONDITIONER, ENGINE PARTS	84007307	2	1002605	4014486496123
24	HYDRAULIC PUMP	89835816	1	1002588	4014486495812
25	ROTARY SCREEN DRIVE	84021590	1	1000082	4014486519341

TL80

	FAN BELT	4796327	1	1002461	4014486493450
--	----------	---------	---	---------	---------------

TL90

	FAN BELT	4796327	1	1002461	4014486493450
--	----------	---------	---	---------	---------------

TN60VA

	AIR CONDITIONING COMPRESSOR DRIVE	87324567	1	1002575	4014486495478
--	-----------------------------------	----------	---	---------	---------------

TN65V

	AIR CONDITIONING COMPRESSOR DRIVE	87324567	1	1002575	4014486495478
--	-----------------------------------	----------	---	---------	---------------

TN70VA

	AIR CONDITIONING COMPRESSOR DRIVE	87324567	1	1002575	4014486495478
--	-----------------------------------	----------	---	---------	---------------

TN75VA

	AIR CONDITIONING COMPRESSOR DRIVE	87324567	1	1002575	4014486495478
--	-----------------------------------	----------	---	---------	---------------

TN95VA

	AIR CONDITIONING COMPRESSOR DRIVE	87324567	1	1002575	4014486495478
--	-----------------------------------	----------	---	---------	---------------

TR 70

6	ROTOR DRIVE (OPT FOR HIGH SPEED)	715785	1	1004170	4014486522808
10	ALTERNATOR AND FAN DRIVE (CATERPILLAR ENGINE DIESEL)	626654	2	1002963	4014486495324

TR 75

11	ROTARY SCREEN (UPPER)	716254	1	No AP	
13	HEADER DRIVE 193	682008	1	1004122	4014486522969
17	AIR COMPRESSOR - 48	259346	1	1004159	4014486523379
17	AIR COMPRESSOR - 48	80259346	1	1004159	4014486523379
22	FEEDER HOUSE FIXED SPEED	621367	1	1004120	4014486522945

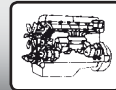
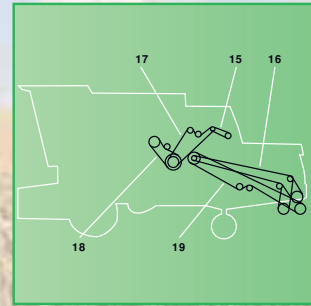
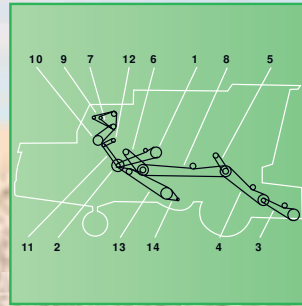
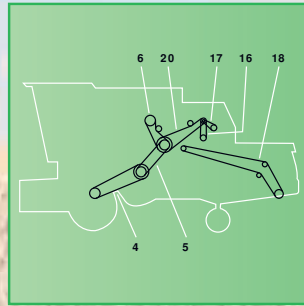
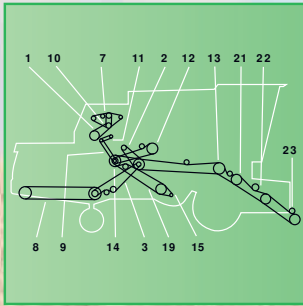

NEW HOLLAND

TR 85

11	RO TARY SCREEN (UPPER)	716254	1	No AP	
13	HEADER DRIVE 193	682008	1	1004122	4014486522969
17	AIR CO MPRESSO R - 48	259346	1	1004159	4014486523379
22	FEEDER HO USE FIXED SPEED	621367	1	1004120	4014486522945

TR 86

4	FEEDER HO USE FIXED SPEED	621367	1	1004120	4014486522945
4	FEEDER DRIVE VARIABLE SPEED	849514	1	1004169	4014486522792
4	SMALL G RAIN SPECIAL	9613963	1	1004140	4014486523201
7	ENG INE FAN HYDRAULIC PUMP	855676	1	1003746	4014486495928
8	HEADER DRIVE	682008	1	1004122	4014486522969
9	ALTERN ATO R DRIVE	626654	2	1002963	4014486495324
10	HYDRAULIC PUMP DRIVE	855676	1	1003746	4014486495928
12	RO TARY SCREEN DRIVE (SECO NDARY)	716254	1	No AP	
15	AIR CO NDIITIO NING CO MPRESSO R DRIVE	259346	1	1004159	4014486523379
15	AIR CO NDIITIO NING CO MPRESSO R DRIVE	577240	1	1002565	4014486495225

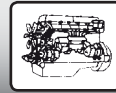
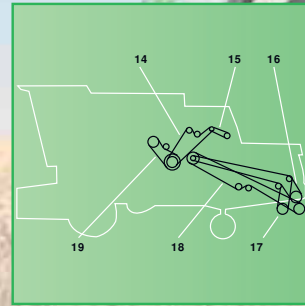
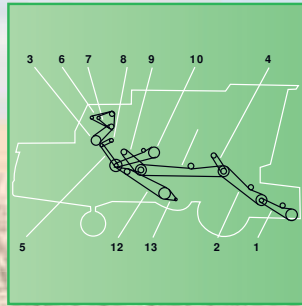
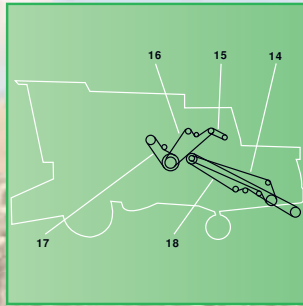
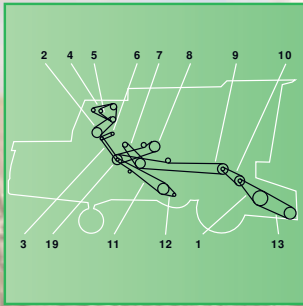

NEW HOLLAND

TR 95

1	FEEDER HO USE FIXED SPEED	621367	1	1004120	4014486522945
2	HYDRAULIC PUMP DRIVE	624650	2	1002841	4014486464078
3	ROTARY SCREEN DRIVE	615790	1	1004108	4014486522839
4	ALTERNATOR AND WATERPUMP DRIVE	626654	2	1002963	4014486495324
6	ALTERNATOR DRIVE	626657	1	1002568	4014486495317
6	ROTARY SCREEN DRIVE (SECONDARY)	716254	1	No AP	
11	SHAKER SHOE DRIVE	774747	1	1001633	4014486485783
12	CLEANING FAN - VARIATOR DRIVE (WITH HOUSING DOWN)	710752	1	1004167	4014486522778
12	CLEANING FAN - VARIATOR DRIVE (WITH HOUSING IN SPEED KIT)	773300	1	1004168	4014486522785
15	AIR CONDITIONING COMPRESSOR DRIVE 48	259346	1	1004159	4014486523379
16	HYDROSTATIC PUMP DRIVE AND MAIN SHAFT	649035	1	1004151	4014486523324
18	STRAW SPREADER DRIVE	618040	1	1004117	4014486522914

TR 96

2	FEEDER HO USE FIXED SPEED	621367	1	1004120	4014486522945
2	FEEDER DRIVE VARIABLE SPEED	849514	1	1004169	4014486522792
2	SMALL GRAIN SPECIAL - 3 HB	9613963	1	1004140	4014486523201
3	HYDRAULIC PUMP DRIVE	624650	2	1002841	4014486464078
3	ENGINE FAN DRIVE	768340	2	1004158	4014486554397
3	ENGINE FAN AND HYDRAULIC PUMP	855676	1	1003746	4014486495928
5	ROTARY SCREEN DRIVE (PRIMARY)	615790	1	1004108	4014486522839
5	ROTARY SCREEN DRIVE (PRIMARY)	859063	1	1004164	4014486522983
6	ALTERNATOR DRIVE	626654	2	1002963	4014486495324
6	ALTERNATOR DRIVE	626657	1	1002568	4014486495317
8	ROTARY SCREEN DRIVE (SECONDARY)	716254	1	No AP	
10	CLEAN GRAIN ELEVATOR DRIVE IMPROVED	9604713	1	1004126	4014486523089
11	HEADER DRIVE	682008	1	1004122	4014486522969
12	SHAKER SHOE DRIVE	774747	1	1001633	4014486485783
14	HYDROSTATIC - MAIN SHAFT DRIVE	649035	1	1004151	4014486523324
14	HYDROSTATIC - MAIN SHAFT DRIVE	797979	1	1004152	4014486523331
15	AIR CONDITIONING COMPRESSOR DRIVE	259346	1	1004159	4014486523379
15	AIR CONDITIONING COMPRESSOR DRIVE	626657	1	1002568	4014486495317
16	STRAW SPREADER DRIVE	618040	1	1004117	4014486522914

TR 97

1	ENGINE FAN HYDRAULIC PUMP	855676	1	1003746	4014486495928
6	CLEAN GRAIN ELEVATOR DRIVE IMPROVED	9604713	1	1004126	4014486523089
7	HEADER DRIVE	682008	1	1004122	4014486522969
8	HYDRAULIC REEL PUMP DRIVE	9609607	1	1000230	4014486463187
9	ROTARY SCREEN DRIVE (PRIMARY)	859063	1	1004164	4014486522983
10	SHAKER SHOE DRIVE	774747	1	1001633	4014486485783
13	FEEDER HO USE FIXED SPEED	621367	1	1004120	4014486522945
15	HYDROSTATIC - MAIN SHAFT DRIVE	797979	1	1004152	4014486523331
16	AIR CONDITIONING COMPRESSOR DRIVE	626657	1	1002568	4014486495317
17	STRAW SPREADER DRIVE	618040	1	1004117	4014486522914

TR 98

1	HYDRAULIC PUMP DRIVE	773255	1	1002582	4014486495638
4	ROTOR VARIATOR DRIVE - STANDARD SPEED ROTOR	86518568	1	No AP	
6	CLEAN GRAIN ELEVATOR DRIVE IMPROVED	9604713	1	1004126	4014486523089
7	HEADER DRIVE	86503087	1	1004123	4014486522976
8	HYDRAULIC REEL PUMP DRIVE	9609607	1	1000230	4014486463187
9	ROTARY SCREEN DRIVE (PRIMARY)	859063	1	1004164	4014486522983

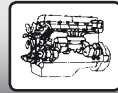
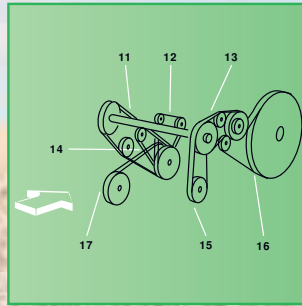
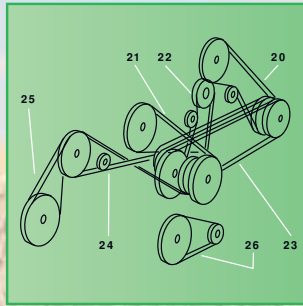
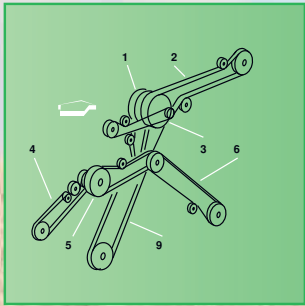

NEW HOLLAND

10	SHAKER SHOE DRIVE	774747	1	1001633	4014486485783
13	FEEDER HOUSE FIXED SPEED	9613963	1	1004140	4014486523201
16	AIR CONDITIONING COMPRESSOR DRIVE	577240	1	1002565	4014486495225
17	STRAW SPREADER DRIVE	618040	1	1004117	4014486522914
20	UNLOADING AUGER DRIVE	86514256	1	1004119	4014486522938

TX 30

1	BEATER TO INTERMEDIATE DRIVE	80455865	1	1001954	4014486490596
2	HYDROSTATIC DRIVE - ENGINE TO BEATER SHAFT	80922872	1	1003667	4014486491302
2	ENGINE TO BEATER SHAFT - MECHANICAL DRIVE	80922911	1	1002004	4014486491319
3	UNLOADING AUGER ENGAGING	89512971	1	1003801	4014486518634
4	STRAW ELEVATOR DRIVE	80433746	2	1000405	4014486466683
5	BEATER TO STRAW ELEVATOR	80350236	1	1003640	4014486489002
6	CLEANING SHOE DRIVE	80448794	1	1000756	4014486471571
9	GROUND SPEED VARIATOR DRIVE	80440780	1	No AP	
11	COOLING FAN DRIVE - INTERMEDIATE SHAFT	80913151	1	1003429	4014486464221
12	WATERPUMP DRIVE	80443634	1	1002543	4014486494723
13	ROTARY DUST SCREEN DRIVE	80913153	1	1000081	4014486484021
16	DUST SCREEN DRIVE	80923019	1	1000166	4014486461916
20	BEATER DRIVE	89513984	1	1000631	4014486469837
21	ROTARY SEPARATOR DRIVE	80754285	1	1000594	4014486469233
22	STORAGE DRIVE GRAIN	80433639	1	1000237	4014486463408
23	DRUM SHAFT TO INTERMEDIATE SHAFT	80434160	1	No AP	
24	STRAW WAIKER - INTERMEDIATE SHAFT DRIVE	80754389	1	1003339	4014486465426
25	STRAW WAIKER DRIVE	80754388	1	1003341	4014486462999
26	CLEANING FAN - VARIATOR DRIVE	89502654	1	1001135	4014486497199

